

MULTIFUNCTIONAL DIGITAL COLOR SYSTEMS

Copying Guide

e-STUDIO5560c/6560c/6570c

Preface

■ How to read this manual

Thank you for purchasing TOSHIBA Multifunctional Digital Systems or Multifunctional Digital Color Systems. This manual describes how to use the copying functions of this equipment. Read this manual before using this equipment.

□ Symbols in this manual

In this manual, some important items are described with the symbols shown below. Be sure to read these items before using this equipment.

⚠ WARNING Indicates a potentially hazardous situation which, if not avoided, could result in death, serious injury, or serious damage, or fire in the equipment or surrounding assets.

⚠ CAUTION Indicates a potentially hazardous situation which, if not avoided, may result in minor or moderate injury, partial damage to the equipment or surrounding assets, or loss of data.

Note Indicates information to which you should pay attention when operating the equipment.

Other than the above, this manual also describes information that may be useful for the operation of this equipment with the following signage:

Tip Describes handy information that is useful to know when operating the equipment.



Pages describing items related to what you are currently doing. See these pages as required.

□ Description of original/paper direction

Paper or originals of A4, B5 or LT size can be placed either in a portrait direction or in a landscape direction. In this manual, “-R” is added to this paper size when this size of paper or original is placed in a landscape direction.

e.g.) A4 size original on the original glass

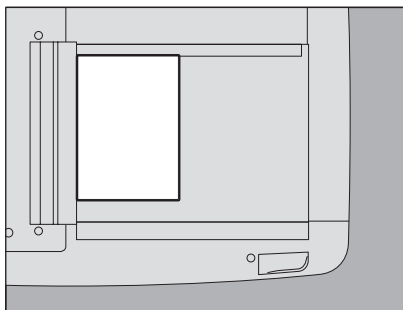

Placed in a portrait direction: A4

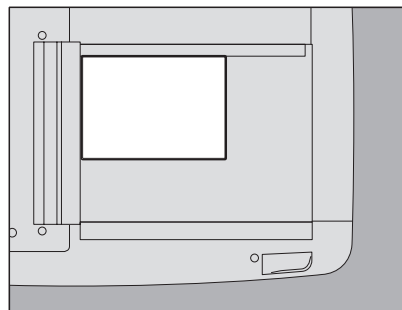

Placed in a landscape direction: A4-R

Paper or originals of A3, B4, LD or LG can only be placed in a landscape direction, therefore “-R” is not added to these sizes.

□ Screens

- Screens in this manual may differ from the actual ones depending on the use-environment of the equipment such as the installing status of options.
- Screens of when paper in the A/B format is used are given in this manual. If you use paper in the LT format, the display or the order of buttons may differ from that of your equipment.

□ Trademarks

The company and product names given in this manual or displayed in this software may be the trademarks of their respective companies.

CONTENTS

Preface.....	1
--------------	---

Chapter 1 BEFORE USING EQUIPMENT

BASIC Menu for the Copier Function	8
Placing Paper.....	11
Acceptable copy paper.....	11
Placing paper in drawers.....	13
Registering paper size.....	16
Setting paper type	17
Placing paper in the Tandem Large Capacity Feeder.....	20
Placing paper in the External Large Capacity Feeder (optional).....	22

Chapter 2 HOW TO MAKE COPIES

Before Making Copies.....	24
Storage of color copies.....	24
Forgery prevention function.....	24
Placing Originals	25
Acceptable originals	25
Placing originals on the original glass	25
Book-type originals.....	26
Using the RADF (Reversing Automatic Document Feeder).....	27
Making Copies	30
Basic copying procedure	30
Scanning the next original during copying.....	33
Interrupting copying and making other copies.....	34
Proof copy	35
Selecting exit tray	36
Bypass Copying	37
Bypass copying	37
Bypass copying on standard size paper.....	38
Bypass copying on non-standard size paper.....	44

Chapter 3 BASIC COPY MODES

Before Using Copying Functions.....	48
Default settings.....	48
Confirming the set functions.....	48
Clearing the set functions	49
Restrictions on function combinations.....	49
Paper Selection.....	50
Automatic Paper Selection (APS).....	50
Selecting desired paper manually	51
Copying mixed-size originals in one operation.....	52
Switching Color Modes.....	54
Setting Original Modes	55
Density Adjustment.....	56
Enlargement and Reduction Copying	57
Automatic Magnification Selection (AMS)	57

Specifying both the original size and the copy paper size separately	59
Specifying reproduction ratio manually.....	61
Copying photo originals in the optimal reproduction ratio for copy paper size (PHOTO ZOOM)	63
Selecting Finishing Mode	66
Finishing modes and optional finishing devices	66
Sort/Group mode	68
Rotate sort mode	69
Staple sort mode	70
Magazine sort / Center fold / Saddle stitch.....	72
Hole punch mode	75
Manual staple mode	76
Duplex Copying	77
Making a 1-sided copy.....	78
Making a 2-sided copy.....	79
Making a 2-sided copy from a book-type original	80
Performing Copy & File.....	82
Setting share folder	84

Chapter 4 EDITING FUNCTIONS

Displaying EDIT Menu.....	88
Image Shift	89
Creating top/bottom margin or left/right margin	89
Creating bookbinding margin.....	90
Edge Erase	92
Book Center Erase	93
Dual Page	95
2IN1 / 4IN1	97
Magazine Sort Mode.....	100
Image Editing	102
Trimming / Masking	102
Mirror image / Negative/positive reversal	105
XY Zoom	106
Cover Sheet.....	107
Sheet Insertion.....	109
Time Stamp	112
Page Number	113
Job Build	115
Image Direction.....	118
Book - Tablet.....	119
ADF -> SADF	120
Full Image.....	121
Image Repeat	122
Omit Blank Page	124

Outside Erase	125
---------------------	-----

Chapter 5 IMAGE ADJUSTMENT

Displaying IMAGE Menu	128
Using Image Adjustment Functions	129
Color balance (YMCK adjustment)	129
RGB adjustment	131
One-touch adjustment	132
Background adjustment	133
Sharpness	134
Twin color copying	135
Mono color copying	140
Hue	141
Saturation	142
ADF Scan Noise Reduction	143

Chapter 6 TEMPLATES

Templates	146
Displaying template menu	146
Using "Useful Templates"	147
Registering Templates	149
Registering templates into the public template group	149
Creating a new private group	152
Registering templates into a private group	154
Recalling Templates	155
Changing Data	157
Changing private group data	157
Changing template data	158
Deleting Groups or Templates	160
Deleting private groups	160
Deleting templates	161

Chapter 7 CONFIRMING JOB STATUS

Confirming Copy Job Status	164
Confirming jobs in progress or ones in waiting	164
Confirming copy job history	169
Confirming drawers	170
Confirming amount of toner remaining	171

Chapter 8 OTHER INFORMATION

Continuous Copying Speed	174
Color copying	174
Black-and-white copying	175
Copying Function Combination Matrix	177
Combination matrix 1/2	177
Combination matrix 2/2	178

Image Adjustment Function Combination Matrix.....	179
Combination matrix 1/2.....	179
Combination matrix 2/2.....	180
INDEX	181

BEFORE USING EQUIPMENT

This chapter describes what you need to know before using this equipment, such as the composition of the BASIC menu for the copying functions and how to place copy paper.

BASIC Menu for the Copier Function	8
Placing Paper.....	11
Acceptable copy paper	11
Placing paper in drawers	13
Registering paper size.....	16
Setting paper type	17
Placing paper in the Tandem Large Capacity Feeder	20
Placing paper in the External Large Capacity Feeder (optional)	22

BASIC Menu for the Copier Function

The BASIC menu for the copier function shows the following information:

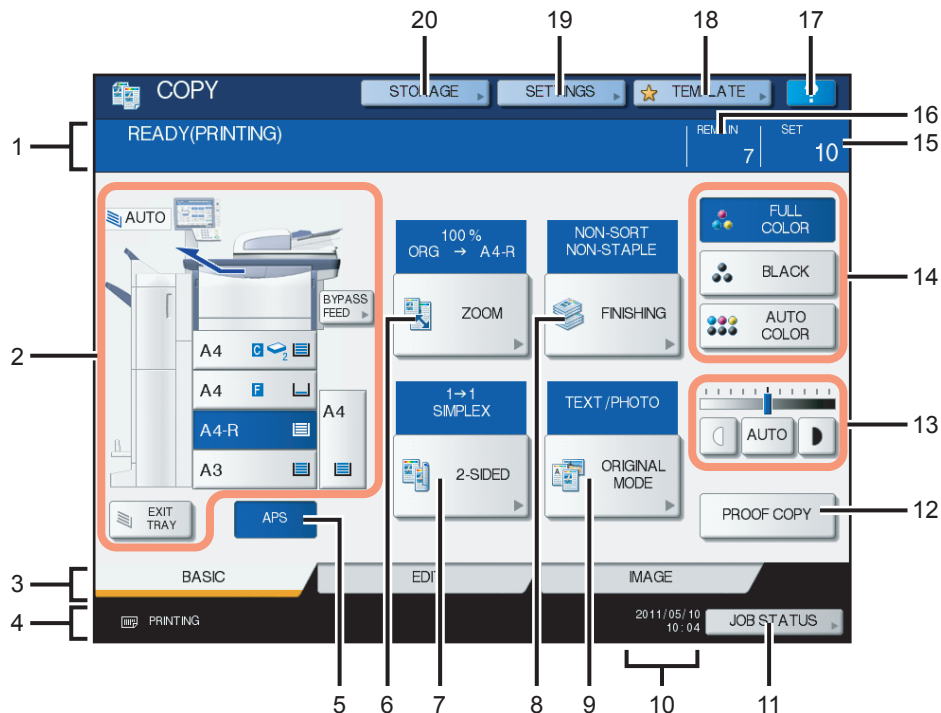

1. Message indication area

This shows a brief description of the functions or the current status of this equipment in message form.

2. Equipment status indication area (📄 P.10)

This shows the size, paper type or amount of paper remaining in each drawer.

3. Index tabs (BASIC, EDIT, IMAGE) (📄 P.87, 📄 P.127)

These are for switching between the menus of "BASIC", "EDIT" and "IMAGE".

4. Alert message indication area

This shows alert messages such as the replacement timing of the toner cartridges or the waste toner box.

When this equipment is managed with the user management function and department management function

In the above case, the job quota assigned to each user or department appears here for approx. 5 seconds after user authentication.

The displayed number is the smaller one of either user (👤) or department (👥).

Tips

- The display may differ depending on the management status of this equipment.
- For details of the user management function or the department management function, ask your administrator.

5. [APS] (automatic paper selection) button (📄 P.50)

This is for changing the mode to automatic paper selection.

6. [ZOOM] button (📄 P.57)

This is for changing the reproduction ratio of images.

7. [2-SIDED] button (📄 P.77)

This is for selecting simplex/duplex copying (e.g. 1 -> 2-sided, 2 -> 2 sided).

8. [FINISHING] button (📄 P.66)

This is for selecting a sorting mode.

9. [ORIGINAL MODE] button (📄 P.55)

This is for selecting an original mode.

10. Date and time**11. [JOB STATUS] button (P.164)**

This is for confirming the processing status of copy, fax, scan or print jobs, and also for viewing their performing history.

12. [PROOF COPY] button (P.35)

This is for making a proof copy to check an image before making a large amount of copies.

13. Density adjustment buttons (P.56)

These are for adjusting the density level of images.

14. Color mode buttons (P.54)

These are for switching color modes.

15. Number of copy sets**16. Number of remaining copy sets****17. [?] (Help) button**

This is for viewing the explanation of each function or the buttons on the touch panel.

18. [TEMPLATE] button (P.145)

This is for the template function.

19. [SETTINGS] button (P.48)

This is for checking currently set functions.

20. [STORAGE] button (P.82)

This is for the storage function.

Equipment status indication area

The equipment status indication area shows the following information:

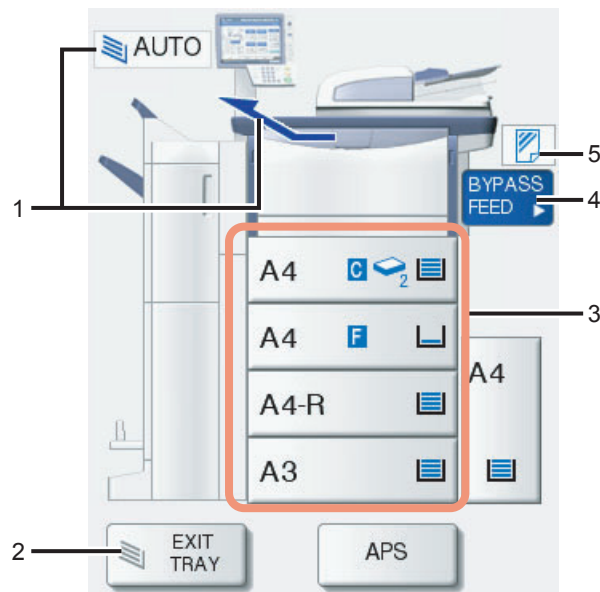

1. Receiving tray indication (📖 P.36)

This shows the tray to which copied paper exits.

2. [EXIT TRAY] button (📖 P.36)

This is for switching receiving (exit) trays.

3. Drawer buttons (📖 P.51)

These show the size of paper, amount of paper remaining in each drawer and the paper type set for the drawer. When you want to use a particular drawer, press the corresponding button.

Tip

The button for the 2 trays of the Tandem Large Capacity Feeder shows the amount remaining in each tray.

Note

If the paper size cannot be detected in this equipment, “⚠️---” appears. In this case, check the following two items.

- Is unacceptable sized paper placed in the drawer?
📖 P.11 “Acceptable copy paper”
- Is the gap between the paper and the side or end guides too big?
📖 P.13 “Placing paper in drawers”

If the indication still remains, contact your service representative.

4. [BYPASS FEED] button (📖 P.37)

When this button is pressed with paper set in the bypass tray, it will be selected as the paper source.

5. Paper type on the bypass tray (📖 P.37)

This shows the type of paper placed on the bypass tray with an icon.

Placing Paper

■ Acceptable copy paper

The following paper can be placed and used for copying.

The values are valid only when Toshiba-recommended paper is used. For the recommended paper, refer to the **Quick Start Guide**.

Notes

- Do not place paper with mixed sizes or paper types in the same drawer.
- Be sure that the height of the stacked paper does not exceed the line indicated on the guides.

Feeder	Paper type	Maximum sheet capacity	Size
Drawers *1	Plain paper, recycled paper (64 - 105 g/m ²) (17 - 28 lb. Bond)	600 sheets (64 g/m ²) (17 lb. Bond) 540 sheets (80 g/m ²) (20 lb. Bond) 500 sheets (81 - 105 g/m ²) (21 - 28 lb. Bond)	A/B format: A3, A4, A4-R, A5-R, B4, B5, B5-R, FOLIO, 305 mm x 457 mm, 320 mm x 450 mm *8, 320 mm x 460 mm *8 LT format: LD, LG, LT, LT-R, ST-R, COMP, 13"LG, 8.5"SQ, 12" x 18" K format: 8K, 16K, 16K-R
	THICK 1 (- 163 g/m ²) (- 90 lb. Index)	300 sheets	
	THICK 2 (- 209 g/m ²) (- 110 lb. Index)	250 sheets	
	THICK 3 (- 256 g/m ²) (- 140 lb. Index)	200 sheets	
Tandem Large Capacity Feeder	Plain paper, recycled paper (64 - 105 g/m ²) (17 - 28 lb. Bond)	2500 sheets (64 g/m ²) (17 lb. Bond) 2360 sheets (80 g/m ²) (20 lb. Bond) 2000 sheets (81 - 105 g/m ²) (21 - 28 lb. Bond)	A4, LT
	THICK 1 (- 163 g/m ²) (- 90 lb. Index)	1400 sheets	
	THICK 2 (- 209 g/m ²) (- 110 lb. Index)	1000 sheets	
	THICK 3 (- 256 g/m ²) (- 140 lb. Index)	800 sheets	
External Large Capacity Feeder (optional)	Plain paper, recycled paper (64 - 105 g/m ²) (17 - 28 lb. Bond)	3000 sheets (64 g/m ²) (17 lb. Bond) 2500 sheets (80 g/m ²) (20 lb. Bond) 2200 sheets (81 - 105 g/m ²) (21 - 28 lb. Bond)	A4, LT
	THICK 1 (- 163 g/m ²) (- 90 lb. Index)	1500 sheets	
	THICK 2 (- 209 g/m ²) (- 110 lb. Index)	1200 sheets	
	THICK 3 (- 256 g/m ²) (- 140 lb. Index)	1000 sheets	

Feeder	Paper type	Maximum sheet capacity	Size
Bypass tray	Plain paper, recycled paper (64 - 105 g/m ²) (17 - 28 lb. Bond)	100 sheets (64 - 80 g/m ²) (17 - 20 lb. Bond) 80 sheets (81 - 105 g/m ²) (21 - 28 lb. Bond)	A/B format: A3, A4, A4-R, A5-R, A6-R, B4, B5, B5-R, FOLIO, 305 mm x 457 mm, 320 mm x 450 mm ^{*8} , 320 mm x 460 mm ^{*8} , 330 mm x 483 mm ^{*8, *9} LT format: LD, LG, LT, LT-R, ST-R, COMP, 13"LG, 8.5"SQ, 12" x 18", 13" x 19" ^{*8, *9} K format: 8K, 16K, 16K-R Non-standard size: Length: 100 - 297 mm (3.9" - 11.7"), Width: 148 - 432 mm (5.8" - 17")
	THICK 1 (- 163 g/m ²) (- 90 lb. Index)	40 sheets	
	THICK 2 (- 209 g/m ²) (- 110 lb. Index)	30 sheets	
	THICK 3 (- 256 g/m ²) (- 140 lb. Index)	30 sheets	
	THICK 4 ^{*2, *3} (- 300 g/m ²) (- 110 lb. Cover)	30 sheets	
	Sticker labels ^{*3, *4}		
	Waterproof paper ^{*5} (- 230 g/m ²)	30 sheets ^{*6, *7}	
OHP film ^{*3}	30 sheets	A4, LT	

*1 Use the bypass tray when you want to make a copy on the back side of copied Thick 1, Thick 2 or Thick 3 paper.

*2 When duplex copying is applied to THICK 4, streaks may appear on the front side of printouts. These streaks may appear clearly when the copied image is dark or when the density level of the entire image is even.

*3 Automatic duplex copying is not available.

*4 For making copies on the sticker labels, select "THICK 2" for the paper type.

*5 For duplex copying, use paper available for duplex copying.

*6 To copy on the back side of copied waterproof paper (SPECIAL 1 is specified for the paper type), place the sheets one by one on the bypass tray.

*7 When making copies on waterproof paper (SPECIAL 1 is specified for the paper type), after about 10 sheets have exited, remove copied sheets from the receiving tray or the tray of the optional finisher.

*8 If an optional finisher has been installed, the upper receiving tray of the finisher and the receiving tray of the equipment are available for paper exiting.

*9 Note that black streaks may appear on the edge of the printed sheets.

Tips

- "LT format" is the standard size only for use in North America.
- "K format" is a Chinese standard size.
- Abbreviations for paper sizes: LT: Letter, LD: Ledger, LG: Legal, ST: Statement, COMP: Computer, SQ: Square

❑ Unacceptable copy paper

Do not use the types of paper shown below. This could cause a paper misfeed.

- Damp paper
- Folded paper
- Curled or creased paper
- Paper whose surface is extremely smooth or rough

Do not use the types of paper shown below. This could cause an equipment malfunction.

- Paper whose surface has had special treatment
- Paper once printed with other copiers or printers

❑ Precautions for storing copy paper

Make sure of the following when storing copy paper:

- Wrap the paper in its wrapping to keep it free from dust.
- Avoid direct sunlight.
- Store in a damp-free space.
- To prevent paper from being folded or bent, store it in a flat place.

■ Placing paper in drawers

Follow the procedure below to place paper in a drawer. For acceptable copy paper, see the following page:

📖 P.11 “Acceptable copy paper”

- 1 Turn the power of this equipment ON.
- 2 Pull out a drawer carefully until it comes to a stop.

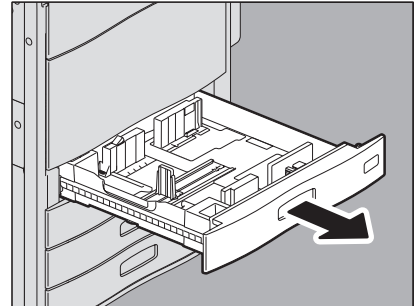

- 3 Push the part shown with an arrow (right side) of the side guide to unlock it.

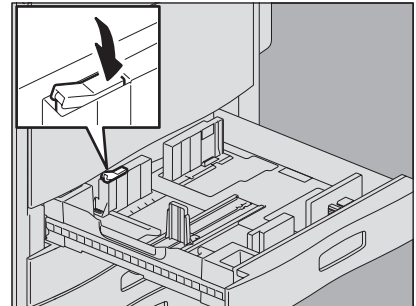

- 4 While holding the green lever of the front side guide, adjust the side guides to the paper size.

Tip

Adjust the side guides with both hands.

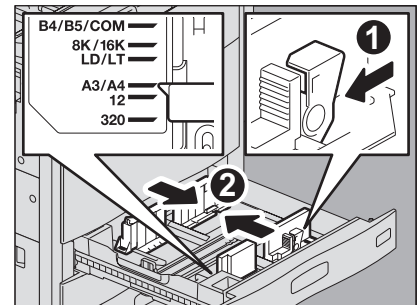

- 5 Push the part shown with an arrow (left side) to lock the side guide.

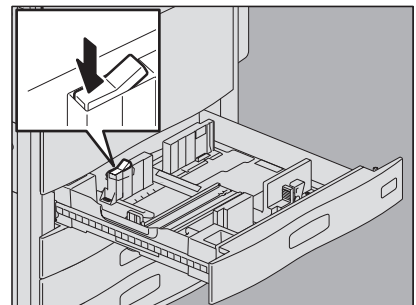

6 Fan and jog the stack of paper well.

Notes

- Fan and jog the stack of paper well before you place it in a drawer, or the sheets may not be separated before being fed.
- Be careful not to cut your fingers when fanning.

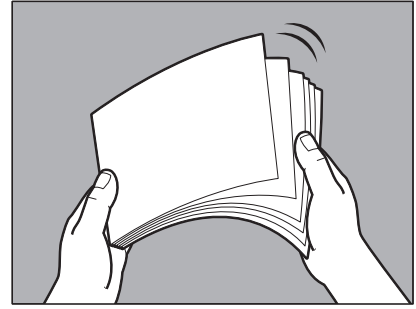

7 Place paper in the drawer.

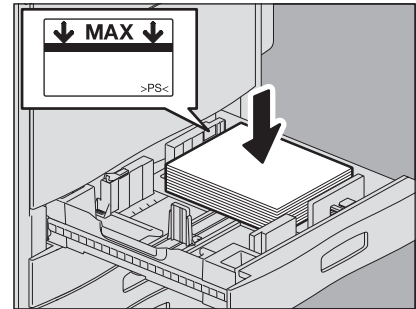

Notes

- Up to 600 sheets (64 g/m²) (17 lb. Bond) can be placed in one drawer. Be sure that the height of the stacked paper does not exceed the line indicated inside of the side guides.
 📖 P.11 "Acceptable copy paper"
- Tidy the paper and place it while aligning it with the right-hand inside surface of the drawer. If there is a gap, paper misfeeding or size detection failure could result.
- Place paper with its copy side up. The copy side may be noted on its wrapping paper.

8 Move the end guide to the trailing edge of the paper while pushing its lower part in the direction of the arrows.

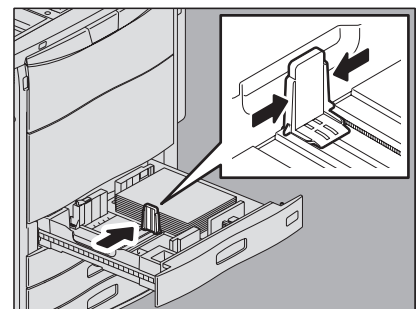

9 Confirm that there is no extra gap between the paper and the side or end guides.

If the gap between the paper and the side or end guides is too big, this equipment may not be able to detect the size of the paper, and this would result in paper misfeeding.

Gap between the paper and the side guides ("A" in the figure on the right): Do not make a gap of more than 0.5 mm (0.02") on one side or 1.0 mm (0.04") on both sides. However, if a paper misfeed occurs in the case of thick paper, create a suitable gap.

Gap between the paper and the end guide ("B" in the figure on the right): Do not make a gap of more than 0.5 mm (0.02").

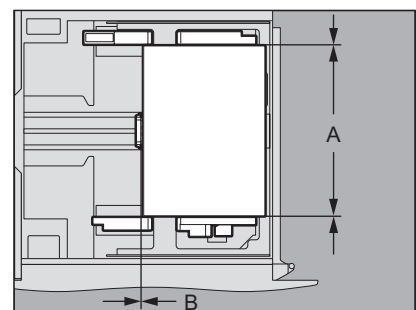

10 Change the paper size indicator if required.

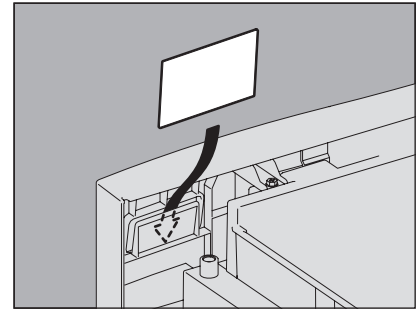

1

11 Push the drawer straight into this equipment carefully until it comes to a stop.

⚠ CAUTION

Be careful not to let your fingers be caught when pushing the drawer into this equipment. This could injure you.

12 The menu below appears. When the size or type of paper is different from the one that was in the drawer, press [NO] on the touch panel. When they are the same, press [YES].

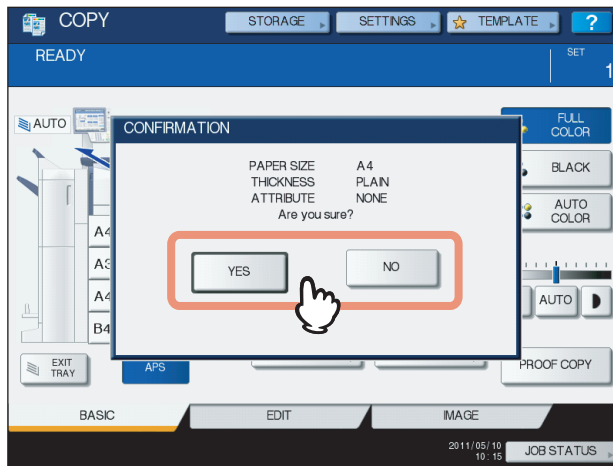

Tips

- The menu above may not appear depending on the setting of this equipment. In this case, see the following pages to change the settings of the paper size and paper type:
 - 📖 P.16 "Registering paper size"
 - 📖 P.17 "Setting paper type"
- If you want to change the setting for displaying this menu, ask your administrator.

If you press [YES], the procedure is completed.

13 Select the size and type of the paper placed in the drawer on the touch panel.

- 1) Select the paper size.
- 2) Select the paper type.
- 3) Press [OK].

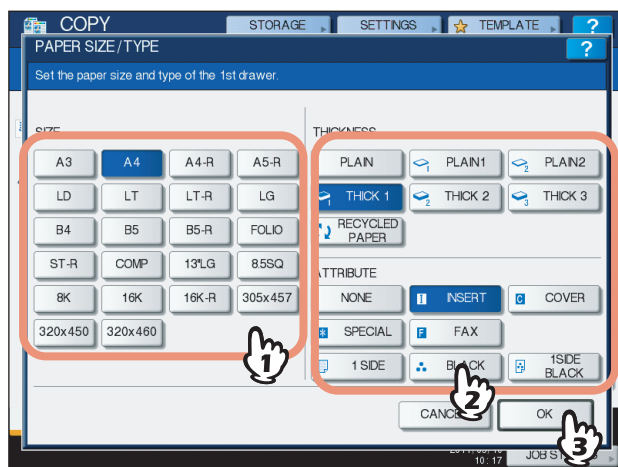

Note

When the paper size has been set to [AUTO (mm)] or [AUTO (inch)], it is registered automatically and its buttons do not appear on this screen. If you want to register the corresponding paper size manually, see the following page to change the settings.

📖 P.16 "Registering paper size"

■ Registering paper size

When you place paper for the first time or you replace the paper with that of a different size, you need to register the size to this equipment.

When paper size is set to be detected automatically:

When [AUTO (mm)] or [AUTO (inch)] has been selected for the paper size, the following procedure is not required. The paper size is set automatically.

- 1 Press the [USER FUNCTIONS] button on the control panel.



- 2 Press the [USER] tab on the touch panel to display the user setting menu, and then press [DRAWER].

3 Select the paper size on the touch panel.

- 1) Select the drawer in which you placed paper.
- 2) Select the paper size.
- 3) Press [OK].

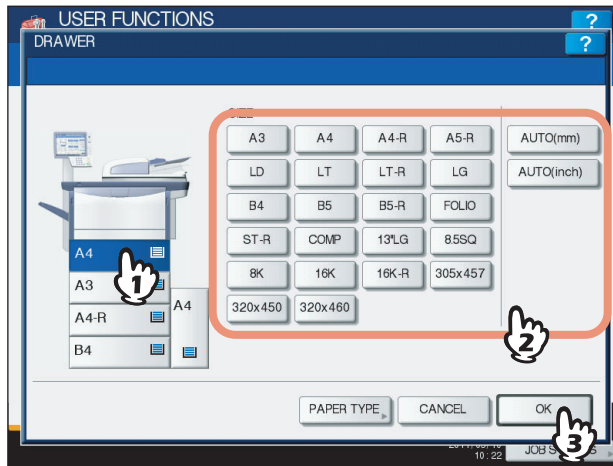

To automatically detect the size of paper placed in a drawer:

Select [AUTO (mm)] when A/B format paper is placed and [AUTO (inch)] when LT format paper is placed instead of selecting a specified paper size. The paper size is automatically registered to the equipment with the automatic paper size detection function when paper is placed in this drawer.

4 Press [CLOSE] on the touch panel or the [USER FUNCTIONS] button on the control panel.

■ Setting paper type

When you place any special paper other than plain paper or that not used for normal copying, you need to set the thickness and attribute into this equipment.

Tips

- The thickness and attribute can be set together.
- When the thickness “THICK 1, 2 or 3”, or an attribute other than “NONE” is set for a drawer, the paper placed in this drawer will not be used for the automatic paper selection mode.
- When an attribute other than “NONE” is set for a drawer, the Automatic Change of Paper Source function (Feeding the same size of paper from a different drawer even if the specified drawer from which paper is being fed is empty) is disabled for the paper in this drawer.



For how to set Automatic Change of Paper Source, refer to the **MFP Management Guide**.

- The set paper type appears on the equipment status indication area with an icon.









📖 P.10 “Equipment status indication area”

Acceptable paper types are as follows:

Thickness

Button	Description	Icon
PLAIN	Select this when you want paper weight (either 64 - 80 g/m ² (17 - 20 lb. Bond) or 81 - 105 g/m ² (21 - 28 lb. Bond)) to be selected automatically.	—
PLAIN 1, 2	Select this when you do not want paper weight to be selected automatically but you want to do it by yourself. PLAIN 1: 64 - 80 g/m ² (17 - 20 lb. Bond) PLAIN 2: 81 - 105 g/m ² (21 - 28 lb. Bond)	
THICK 1 - 3	Thick paper THICK 1: 106 - 163 g/m ² (29 lb. Bond - 90 lb. Index) THICK 2: 164 - 209 g/m ² (91 lb. Index - 110 lb. Index) THICK 3: 210 - 256 g/m ² (111 lb. Index - 140 lb. Index)	
RECYCLED PAPER	Recycled paper	

Attribute

Button	Description	Icon
NONE	No attribute specified	—
INSERT	Sheets used in the sheet insertion mode  P.109 "Sheet Insertion" Up to 2 types of sheets (Insertion sheets 1 and 2) can be set. To set Insertion sheet 1 and 2, select the drawer for Insertion sheet 1 and press [INSERT], and then select a drawer for Insertion sheet 2 and press [INSERT].	
COVER	Sheets used in the cover sheet mode  P.107 "Cover Sheet"	
SPECIAL	Colored paper or paper with watermarks, etc.	
FAX *1, *2, *3	FAX paper	
1SIDE	Only 1-sided copy allowed	
BLACK	Only black and white copy allowed	
1SIDE BLACK	Only 1-sided black and white copy allowed	

*1 Fax transmission and reception is available only when the FAX Unit (optional) is installed.

*2 When lists are printed, paper set as "FAX" is used. For printing lists, refer to the *MFP Management Guide*.

*3 When "ROTATE SORT" is turned ON for RX printing in the FAX menu, "FAX" cannot be set for attribute. For how to set RX printing, refer to *GD-1250/GD-1260/GD-1270 Operator's Manual for FAX Unit*.

- 1 Press the [USER FUNCTIONS] button on the control panel.



- 2 Press the [USER] tab on the touch panel to display the user setting menu, and then press [DRAWER].

3 Press [PAPER TYPE].

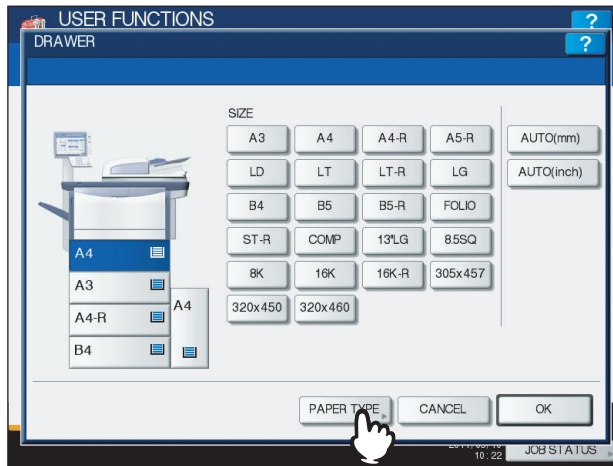

4 Select the paper type.

- 1) Select the drawer in which you placed paper.
- 2) Select the paper type.
- 3) Press [OK].

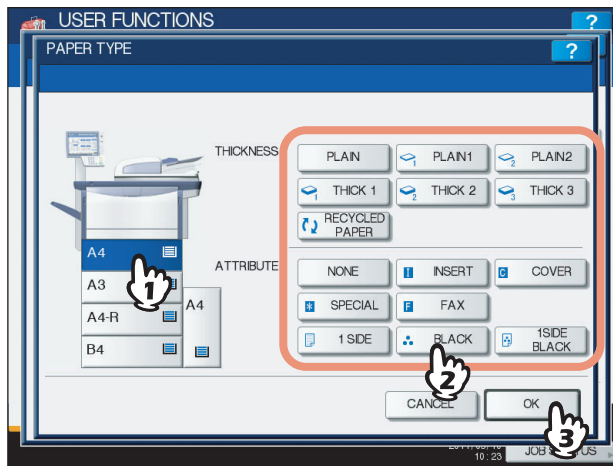

5 Press [OK].

6 Press [CLOSE] on the touch panel or the [USER FUNCTIONS] button on the control panel.

Clearing the set paper type

Press the drawer button on the menu in step 4, and then press the paper type whose setting you want to clear.

Tip

If both INSERT 1 and INSERT 2 are set and you clear the setting of only INSERT 1, the setting for INSERT 2 automatically becomes the setting for INSERT 1.

■ Placing paper in the Tandem Large Capacity Feeder

Note

This operation is applied only to the Tandem Large Capacity Feeder type.

1 Pull out the drawer of the Tandem Large Capacity Feeder carefully until it comes to a stop.

⚠ CAUTION

Do not touch the slide rail ("A" in the figure on the right). This could injure you.

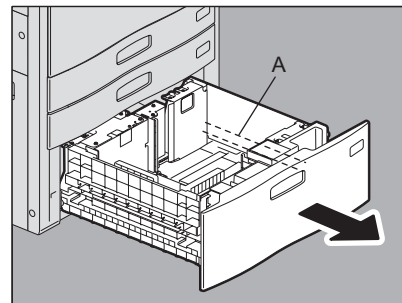

2 Place 2 stacks of paper in the right and left trays correspondingly.

Fan and jog the paper well before placing it. Place it with its copy side up. Place one stack of paper in the right-hand tray (shown as "A" in the figure) with its side touching the right corner of the tray, and place the other stack of paper in the left-hand tray (shown as "B" in the figure) with its side touching the left corner of the tray. Paper can be placed neatly if you divide stacks into small bundles and pile them up on the two trays alternately.

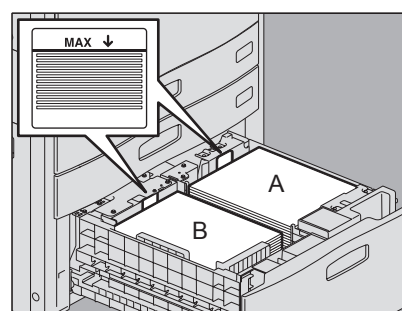

Notes

- Paper in the right-hand tray is used first. When it runs out, paper in the left-hand tray will be moved automatically to the right-hand tray and fed.
- A maximum of 2360 sheets (80 g/m²) (20 lb. Bond) can be placed in the 2 trays. However the stack height of the paper must not exceed the line indicated inside the side guides.
 📖 P.11 "Acceptable copy paper"
- The copy side may be noted on its wrapping paper.
- Be careful not to cut your fingers when fanning the paper.
- When placing paper, be sure that the center lever is not open. (See the label attached in the Tandem Large Capacity Feeder.)

3 Push the drawer of the Tandem Large Capacity Feeder straight into this equipment carefully.

When the drawer is completely inserted, the right-hand tray will move up to the paper feeding position.

Note

Do not slam the drawer shut. Stacked sheets may collapse and they cannot be transported correctly.

⚠ CAUTION

Be careful not to let your fingers be caught when pushing the drawer into this equipment. This could injure you.

4 Change the paper type as required.

📖 P.17 "Setting paper type"

□ Adding paper in the Tandem Large Capacity Feeder during copying

When the paper on the left tray of the Tandem Large Capacity Feeder has run out during copying, "Paper for left drawer can be added." appears. You can pull out the Tandem Large Capacity Feeder and add paper to the left tray without stopping copying. This is useful when you wish to make a large amount of copies quickly.

1 Pull out the drawer of the Tandem Large Capacity Feeder carefully until it comes to a stop.

Only the left tray will come out.

⚠ CAUTION

Do not touch the slide rail ("A" in the figure on the right). This could injure you.

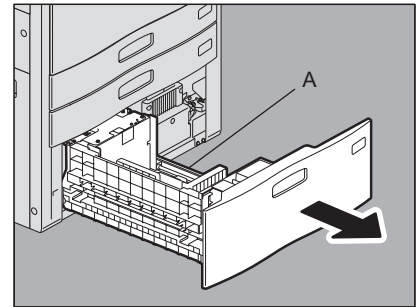

2 Place paper on the left tray.

Place paper aligning to the left-hand side of the tray.

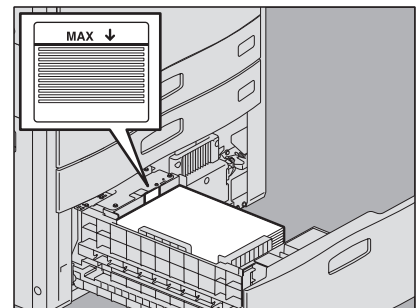

3 Push the drawer of the Tandem Large Capacity Feeder straight into this equipment carefully.

When the paper on the right tray has run out, that on the left tray will be automatically shifted to the right tray.

Note

Do not slam the drawer shut. Stacked sheets may collapse and they cannot be transported correctly.

⚠ CAUTION

Be careful not to let your fingers be caught when pushing the drawer into this equipment. This could injure you.

■ Placing paper in the External Large Capacity Feeder (optional)

1 Pull out the drawer of the External Large Capacity Feeder carefully until it comes to a stop.

⚠ CAUTION

Do not touch the slide rails ("A" in the figure on the right). This could injure you.

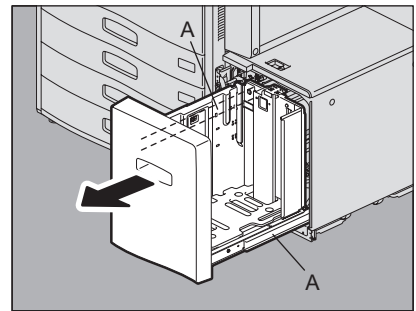

2 Place paper on the tray.

Fan and jog the paper well before placing it on the tray. Place it with its copy side up. Do not allow any gap between the paper and the rear side guide.

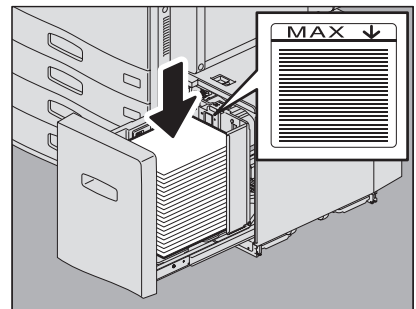

Notes

- A maximum of 3000 sheets (64 g/m²) (17 lb. Bond) can be placed. However the stack height of the paper must not exceed the line indicated on the rear side guide.
 ☞ P.11 "Acceptable copy paper"
- The copy side may be noted on its wrapping paper.
- Be careful not to cut your fingers when fanning the paper.
- Do not allow any gap between the paper and the rear side guide. If there is any gap, the copied image may be skewed.

3 Push the drawer of the External Large Capacity Feeder straight in carefully.

When the drawer is completely inserted, the tray will move up to the paper feeding position.

⚠ CAUTION

Be careful not to let your fingers be caught when pushing the drawer into this equipment. This could injure you.

HOW TO MAKE COPIES

This chapter explains the basic copying procedures.

Before Making Copies	24
Storage of color copies	24
Forgery prevention function.....	24
Placing Originals	25
Acceptable originals	25
Placing originals on the original glass	25
Book-type originals	26
Using the RADF (Reversing Automatic Document Feeder)	27
Making Copies	30
Basic copying procedure	30
Scanning the next original during copying.....	33
Interrupting copying and making other copies.....	34
Proof copy	35
Selecting exit tray	36
Bypass Copying	37
Bypass copying	37
Bypass copying on standard size paper	38
Bypass copying on non-standard size paper.....	44

Before Making Copies

■ Storage of color copies

When storing color copies, be careful of the following:

- Avoid a place exposed to light. The colors may fade when they are stored in such a place for a long time.
- If copies are stored pressed between plastic sheets made of chloroethylene for a long time, toner may melt and stick to the plastic. For long-time storage, use polyethylene binders.
- When a color copy is folded, toner at the folded part may flake off. Do not fold color copies when storing them.
- Toner on copies may melt if it touches solvent or ink not fully dried. Keep copies away from them.
- When copies are left under an extremely high temperature environment such as in the vicinity of a heater, toner may melt. Store them at room temperature and avoid extreme temperature changes.

■ Forgery prevention function

This equipment has a forgery prevention function. Therefore, scan or copy function might not operate correctly.

Placing Originals

Acceptable originals

When the RADF (Reversing Automatic Document Feeder) is used, 2-sided originals can be automatically scanned one sheet after another. When the original glass is used, originals such as OHP films, tracing paper, booklet or 3-dimensional objects, that cannot be placed on the RADF can be scanned, as well as plain paper.

Location	Maximum size	Paper weight	Acceptable sizes for automatic size detection
Original glass	Length: 297 mm (11.69") Width: 432 mm (17.01")	—	Other than North America: A3, A4, A4-R, A5-R, B4, B5, B5-R North America: LD, LG, LT, LT-R, ST-R
RADF		1-sided originals: 35 - 209 g/m ² (9.3 - 110 lb.) *1 2-sided originals: 50 - 157 g/m ² (13.3 - 41.8 lb.)	Other than North America: A3, A4, A4-R, A5-R, B4, B5, B5-R, FOLIO North America: LD, LG, LT, LT-R, ST-R, COMP

*1 You may not obtain enough image quality when an original with a paper weight of more than 157 g/m² (41.8 lb.) is used.

Notes

- Automatic size detection does not work properly when A/B format originals are used in equipment for North America. It does not work properly when LT format originals are used in equipment other than that for North America.
- Automatic size detection does not work properly when K format paper is used for printing. (K format is a standard paper size in China.)
- Do not place any heavy objects (4 kg (9 lb.) or over) on the original glass and do not press on it with force.
- Be sure to place ST-size or A5-size originals in a landscape direction when using the RADF.
- A maximum of 1000 sheets can be scanned per 1 copy job or up until the embedded memory becomes full.

Placing originals on the original glass

The original glass can be used for originals such as OHP films or tracing paper, as well as plain paper, that cannot be placed on the RADF.

CAUTION

Do not place any heavy objects (4 kg (9 lb.) or over) on the original glass and do not press on it with force. Breaking the glass could injure you.

1 Raise the RADF.

Note

Raise it 60 degrees or more so that the size of the original can be detected correctly.

2 Place the original with its face down on the original glass and align it with the left rear corner of the glass.

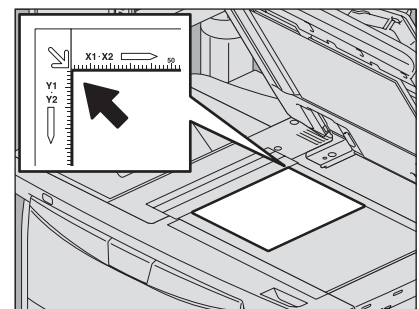

When you copy highly transparent originals

When you copy highly transparent originals such as OHP films or tracing paper, place a blank sheet, which is the same size as the original or larger, over the original.

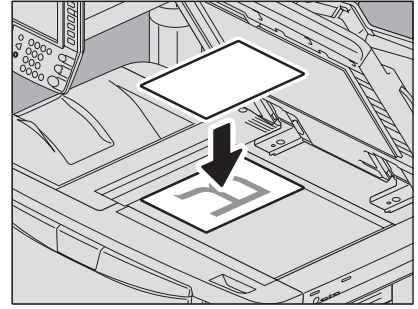
**3 Lower the RADF carefully.****■ Book-type originals**

You can place book-type originals on the original glass.

⚠ CAUTION

Do not place any heavy objects (4 kg (9 lb.) or over) on the original glass and do not press on it with force. Breaking the glass could injure you.

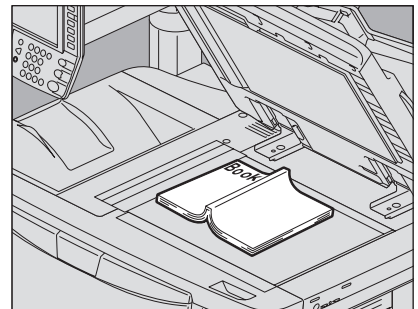
1 Raise the RADF.**2 Open the desired page of the original and place it with its face down. Align it with the left rear corner of the original glass.**

When you make 2-sided copies from book-type originals in modes such as book-type original to 2-sided copying or dual page copying, align the center of the original on the yellow indicator line of the original glass.

📖 P.80 "Making a 2-sided copy from a book-type original"

📖 P.95 "Dual Page"

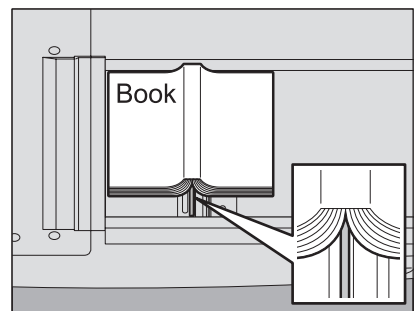
**3 Lower the RADF carefully.****Notes**

- Do not lower the RADF forcibly when the original is very thick. There will be no problem in copying even if it is not fully lowered.
- Do not look directly at the original glass because intensive light may escape during copying.

■ Using the RADF (Reversing Automatic Document Feeder)

□ Precautions

Do not use the types of originals 1 to 9 shown below because such originals may cause misfeeding or damage to the equipment.

1. Badly wrinkled, folded or curled originals
2. Originals with carbon paper
3. Taped, pasted or cut-out originals
4. Originals with multiple perforations such as loose leaf paper
5. Clipped or stapled originals
6. Originals with holes or tears
7. Damp originals
8. OHP films or tracing paper
9. Coated paper (with wax, etc.)

Use the types of originals 10 and 11 shown below with extra care.

10. Originals which resist sliding with the fingers, or surface-treated originals (The sheets of such originals may not be separated.)
11. Folded or curled originals (They should be fully smoothed out before being used.)

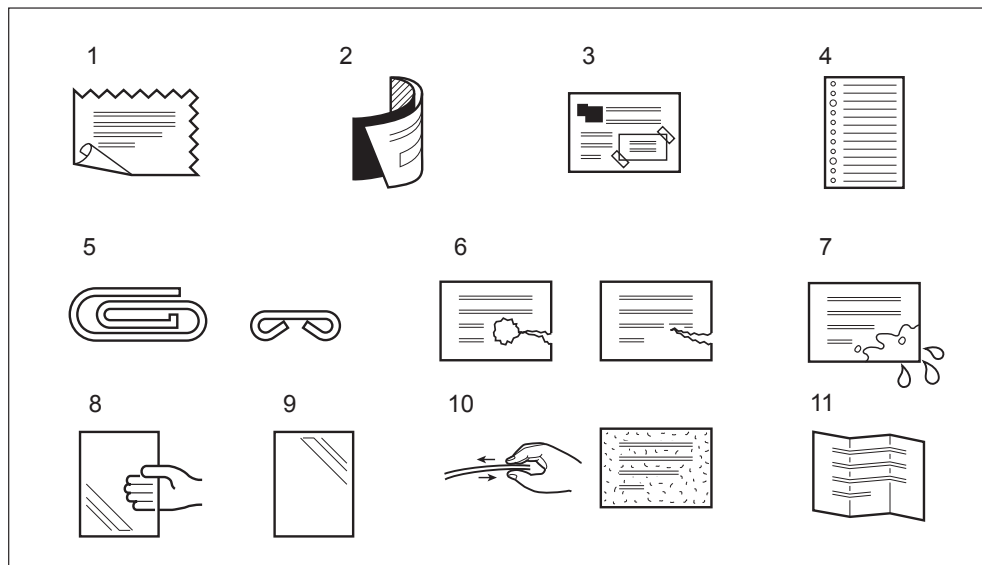

When black streaks appear

If the scanning area or the guide area is dirty, image trouble such as black streaks may occur on printouts. Weekly cleaning of these areas is recommended. For cleaning, refer to the **Quick Start Guide**.

□ Continuous feed mode

The feeding mode is set at “continuous feed mode” by default. Once you set the originals and then press the [START] button, they are scanned page by page continuously. It is useful when you want to copy more than one original at one time.

1 Align all the originals.

Collate the originals in the order that you want them to be copied. The top sheet of the originals will be copied first.

2 Place the originals with their face up and align the side guides to the original length.

Notes

- Regardless of their sizes, originals are acceptable up to 100 sheets (35 to 80 g/m² (9.3 to 20 lb.)) or 16 mm (0.62") in height.
- For mixed-size originals, see the following page:
 P.52 “Copying mixed-size originals in one operation”

For long originals

Pull out the original stopper so that the scanned original will not fall off.

Note

After the original stopper was used, lift it slightly and push it in.

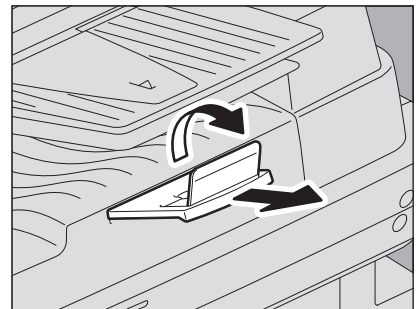
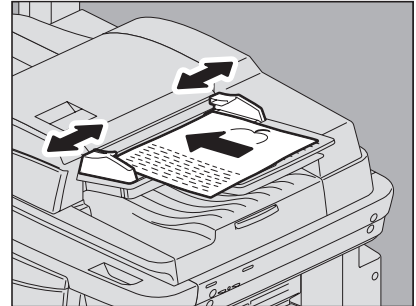

Tip

When there are too many originals to be scanned at one time, divide the originals into several sets before copying. Place the first set of the originals and then press [CONTINUE] on the touch panel while the data of this set are being scanned. When this scanning is finished, place the next set of the originals and press the [START] button on the control panel. (If you press [CONTINUE] just before the originals finish being scanned, this button may not work.)

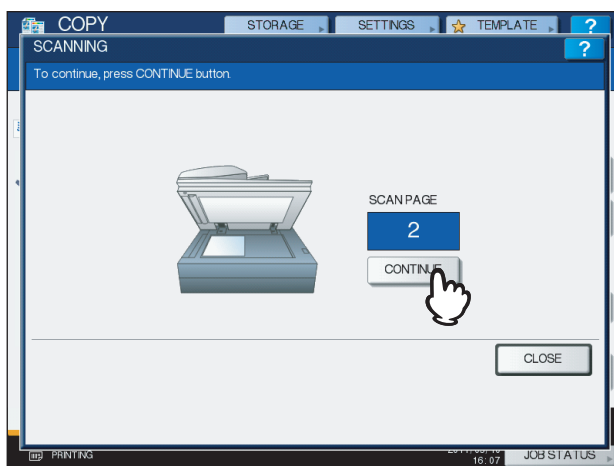

□ Single feed mode

When the feeding mode is set at “single feed mode”, an original is fed automatically as it is placed on the RADF. It is useful when you want to copy only 1 original sheet.

📖 P.120 “ADF -> SADF”

2

1 Align the side guides to the original length.

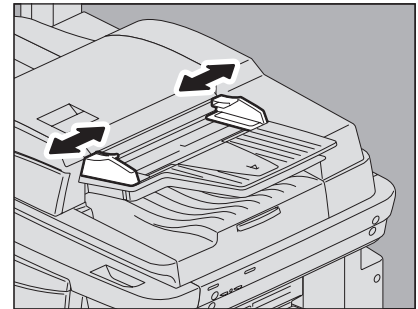

2 Insert the original with its face up and straight along the side guides.

The original is automatically pulled in and then the menu of step 3 will be displayed on the touch panel.

Note

Be sure to let go of the original when it starts being pulled.

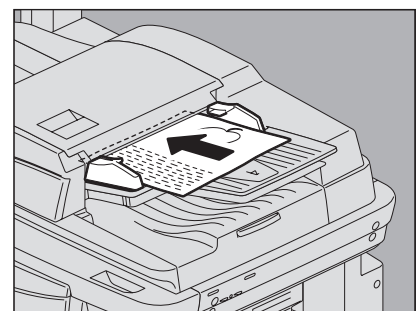

3 If there is another original, insert it in the same way.

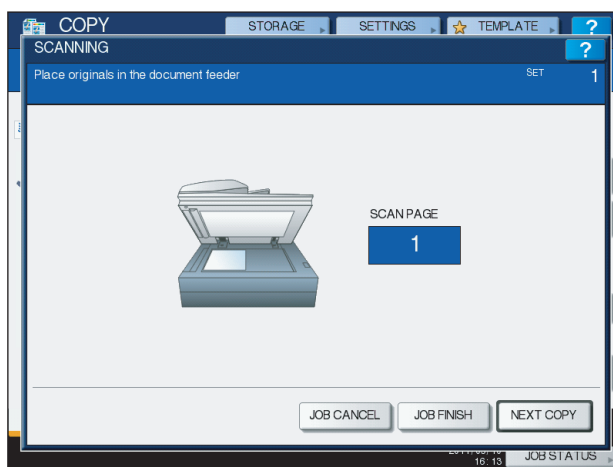

4 After all the originals are pulled in, press [JOB FINISH].

Tip

If you want to stop copying, press [JOB CANCEL].

Making Copies

■ Basic copying procedure

Make copies following the procedure below.

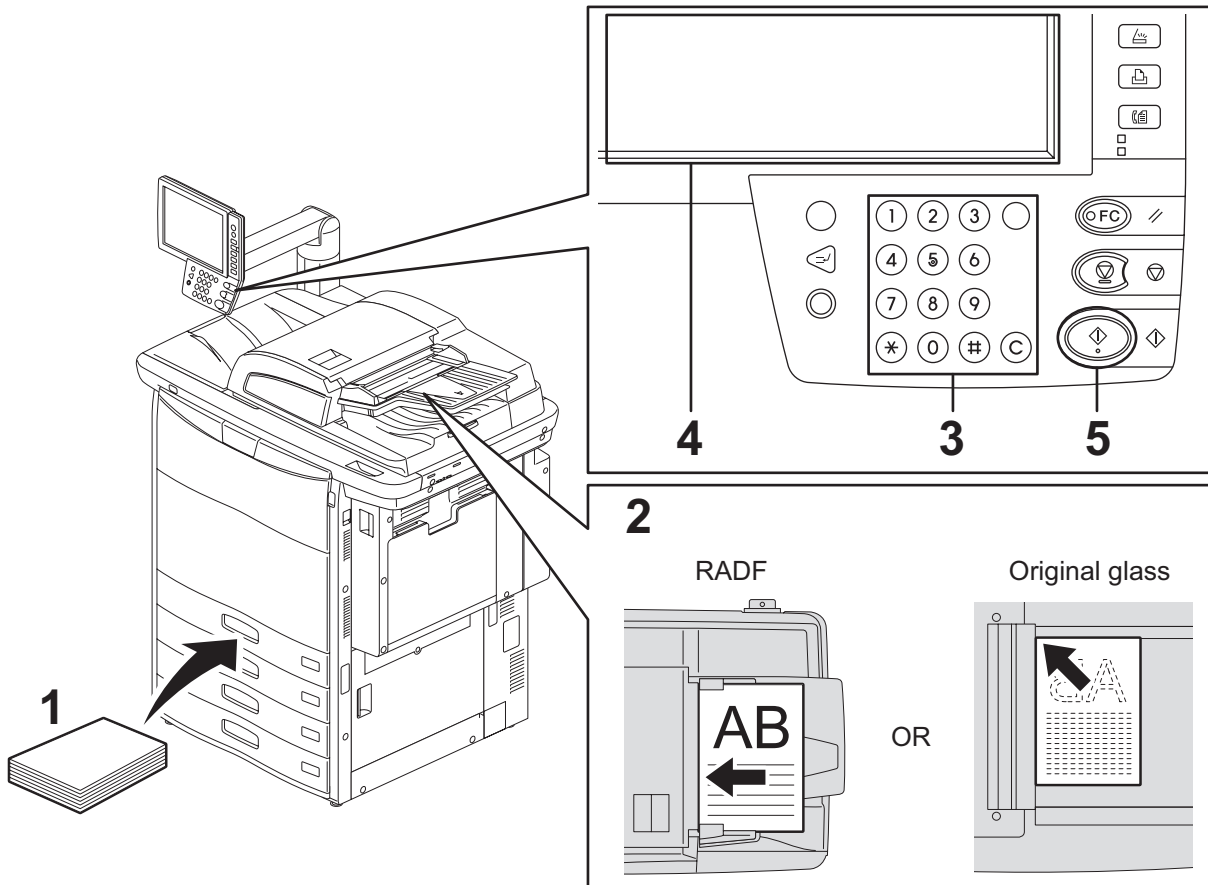

1 Make sure that paper is placed in the drawer(s).

For the types and sizes of acceptable paper and how to place it, see the following pages:

- 📖 P.11 "Acceptable copy paper"
- 📖 P.13 "Placing paper in drawers"
- 📖 P.20 "Placing paper in the Tandem Large Capacity Feeder"
- 📖 P.22 "Placing paper in the External Large Capacity Feeder (optional)"

2 Place the original(s).

For the types and sizes of originals and how to place them, see the following pages:

- 📖 P.25 "Acceptable originals"
- 📖 P.27 "Using the RADF (Reversing Automatic Document Feeder)"
- 📖 P.25 "Placing originals on the original glass"
- 📖 P.26 "Book-type originals"

3 Key in the desired number of copies if you want more than one copy.

Press the [CLEAR] button on the control panel to delete the number keyed in.

4 Select the copy modes as required.

- 📖 P.47 "BASIC COPY MODES"
- 📖 P.87 "EDITING FUNCTIONS"
- 📖 P.127 "IMAGE ADJUSTMENT"

5 Press the [START] button on the control panel.

Copying starts. The paper exits with its copied side down.

Note

Be careful because the paper exiting area and the paper itself are hot.

2

The menu shown below may appear when you are using particular modes.

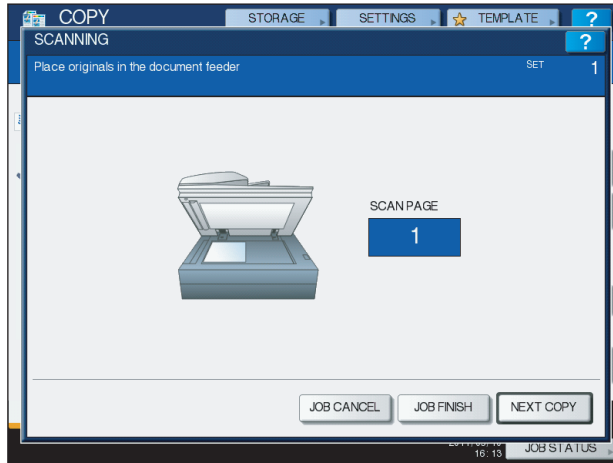

This menu appears when “SADF (single feed mode)” is set to the document feeder or in modes where the original is placed on the original glass and the scanned data are temporarily stored in the memory, such as sort copying or 1-sided to 2-sided copying. When this menu appears, follow the procedure below.

Tip

There are different messages displayed on the upper part of the menu for when the originals are scanned through the RADF and for when scanning is performed through the original glass.

6 Place the next original, and then press the [START] button on the control panel or [NEXT COPY] on the touch panel.

Scanning starts. (When “SADF (single feed mode)” is set to the document feeder, an original is fed automatically when it is placed on the RADF.)

7 Press [JOB FINISH] on the touch panel after all the originals have been scanned.

Copying starts.

Tips

- If you want to stop copying, press [JOB CANCEL].
- When the drawer runs out of paper during copying, another drawer can feed paper instead if it holds paper of the same size and orientation, and copying will not stop. If there is no such drawer, copying stops and “Add paper” appears on the touch panel. In this case, add paper to the drawer.

□ Stopping and restarting copying

- 1 Press the **[STOP]** button on the control panel.
Copying or scanning stops.

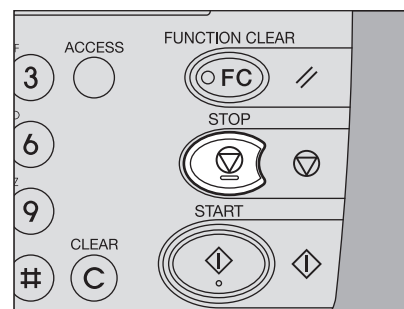

- 2 Press **[JOB CANCEL]** on the touch panel to stop copying. Press **[NEXT COPY]** on the touch panel or the **[START]** button on the control panel to restart.

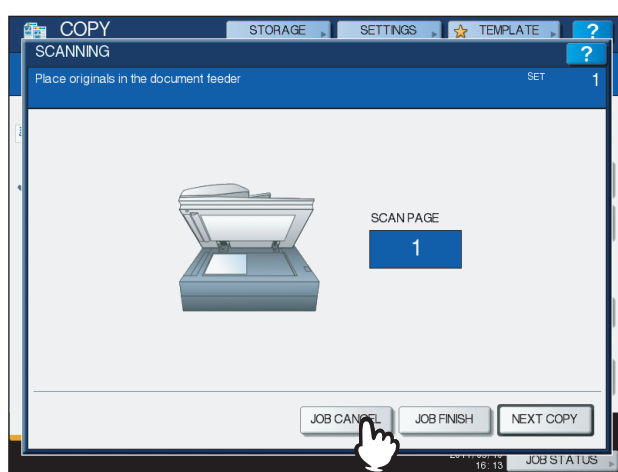

When you press **[JOB CANCEL]**, the scanned data will be deleted and any waiting jobs will be performed.

Tip

Even if you do not press **[JOB CANCEL]**, the scanned data will be deleted by means of the automatic function clear.

■ Scanning the next original during copying

Even if copying is in progress or “READY (WARMING UP)” is displayed on the touch panel, you can scan the next original (auto job start).

1 Place the original(s).

2 Set the number of copy sets and the copy modes as required.

Note

The new job starts in the copy modes that you previously selected unless you select other modes.

3 Press the [START] button on the control panel.

Tip

A maximum of 1000 sheets can be scanned per 1 copy job or up until the embedded memory becomes full.

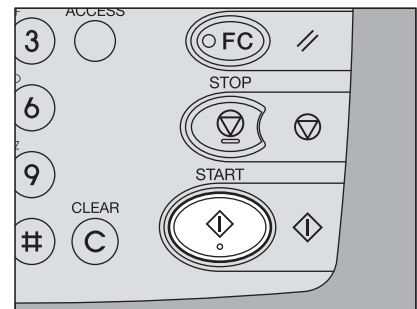

Confirming auto jobs

You can confirm which jobs are in waiting on the touch panel or cancel them as required. For details, see the following page:

📖 P.164 “Confirming Copy Job Status”

Canceling jobs being scanned

Press the [STOP] button on the control panel to stop a job while originals are being scanned.

When you press [JOB CANCEL] on the touch panel or the [FUNCTION CLEAR] button on the control panel while the scanning is being paused, the scanning will end. (In this case, the data which were scanned before the job was paused will be copied.) To restart the scanning, press the [START] button.

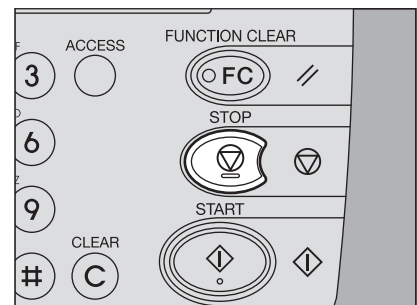

■ Interrupting copying and making other copies

You can interrupt the copy job in progress to make other copies (interrupt copying). When restarting the interrupted job, you do not have to reselect copy modes that have been set because they are memorized in this equipment.

Notes

- The following functions cannot be used together with interrupt copying:
Cover sheet copying, Sheet insertion copying, Job build, Store to e-Filing, Copy & File
- During interrupt copying, the mode cannot be changed to a non-copying one, such as e-Filing, scanning, printing or fax. To change the mode, first press the [INTERRUPT] button to clear the interrupt copying.

1 Press the [INTERRUPT] button on the control panel.

“Job interrupted job 1 saved.” appears, “INTERRUPT” is displayed on the function display, and the [INTERRUPT] button lights.

Tip

If the original is being scanned, the message above appears after the scanning has finished.

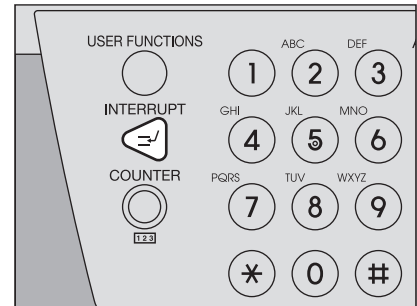

2 Replace the original with a new one.

3 Select other copy modes as required and then press the [START] button on the control panel.

4 Press the [INTERRUPT] button again after the interrupt copying has finished.

“Ready to resume job 1” appears and the interrupted job restarts.

■ Proof copy

When you make a large amount of copies, you can check if they will be made exactly as you desire by copying only one page before copying them all (proof copy). Then you can change the modes or settings (e.g. the number of copy sets, receiving tray, page number, time stamp, sort/stapling, hole punching) after checking the proof copy.

Note

If you want to change settings such as the reproduction ratio, density, original mode or 1/2-sided copying, you must finish the proof copy first. Then change these settings and scan the original again.

- 1 Place paper in the drawer(s).**
- 2 Place the original(s).**
- 3 Select the number of copy sets and copy modes.**
- 4 Press [PROOF COPY] on the touch panel.**
 "PROOF COPY is set Press START button to copy" appears for approx. 2 seconds.

Note

If [NON-SORT NON-STAPLE] or [GROUP] is selected as a finishing mode, the mode will be changed to [SORT] automatically.

- 5 Press the [START] button on the control panel.**
 Scanning starts. 1 set of copies will be printed out.
- 6 Change the number of copy sets and copy modes as required after checking the proof copy.**
 Modes or settings such as the number of copy sets, the receiving tray, page number, time stamp, sort/stapling and hole punching can be changed.



Note

If you want to change settings such as the reproduction ratio, density, original mode or 1/2-sided copying, you must finish the proof copy first. Then change these settings and scan the original again. Press [MEMORY CLEAR] on the touch panel or the [FUNCTION CLEAR] button on the control panel to end the proof copy.

7 Press the [START] button on the control panel.

If you did not change the number of copies in step 6 above, the number of copies printed out will be one fewer than that previously set because you have already copied one as a proof copy. (However, if the number of copies you previously set was 1, another set of copies will be printed out besides the proof copy.)

■ Selecting exit tray

You can select the exit tray.

Notes

- Exit trays that can be selected vary depending on whether the finisher is installed or not.
- The available exit tray may be restricted depending on copy modes and paper sizes.
- Exit tray selection is set at automatic selection by default.

Changing the exit tray

The exit tray currently selected is displayed on the equipment status indication area. To change the exit tray, press [EXIT TRAY]. The display changes every time you press this from the exit trays of the equipment, those of the Finisher (optional) and automatic selection in order.

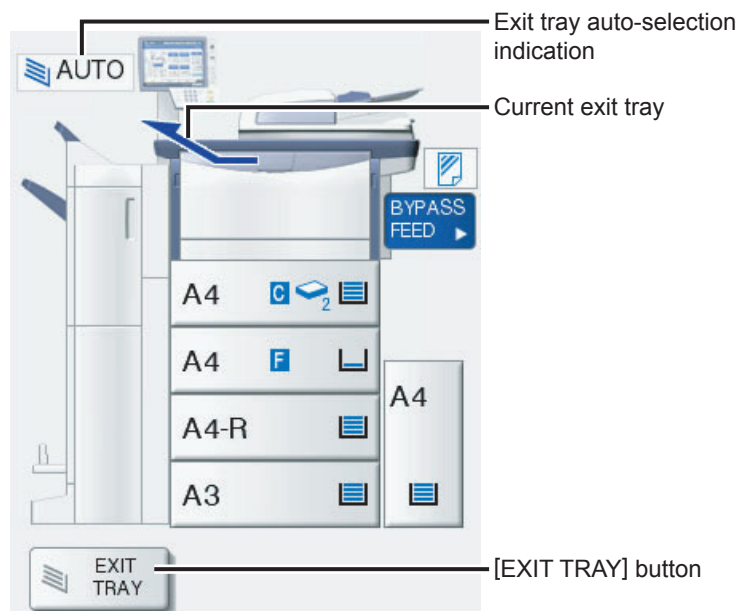

Bypass Copying

■ Bypass copying

When you make copies on OHP film, sticker labels, Thick 4 paper or non-standard size paper, place copy paper on the bypass tray. Bypass copying is also recommended for copying on standard size paper which is not set in any of the drawers.

Tips

- If you select the paper size, you can utilize various functions such as the automatic paper selection (APS) or the automatic magnification selection (AMS). For details, see the following page:
 P.177 "Copying Function Combination Matrix"
- If you place the originals on the RADF for bypass copying and do not set the paper size, the originals will be copied upside down. Be sure to set the paper size when you wish to do bypass copying.

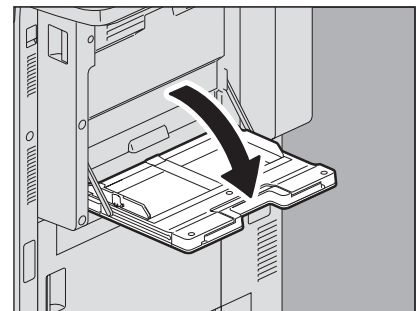

Open the bypass tray for bypass copying.

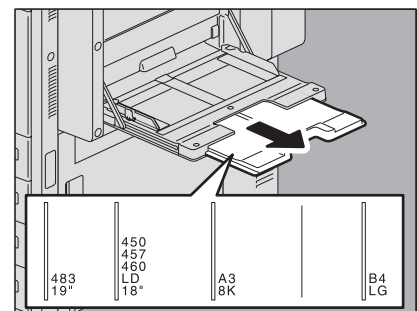

Before placing large paper, pull out the paper holder. You can extend it appropriately by matching the paper size with its scale.



The operating procedure for bypass copying differs depending on the paper size to be used. See the table below for the operating procedure of each size.

Paper size		Procedure
Standard size	Other than North America: A3, A4, B4, B5 North America: LD, LT, LG, ST-R	 P.38 "Copying on A3, A4, B4 and B5 size paper (in equipment other than for North America) / LD, LT, LG and ST-R size paper (in equipment for North America)"
	Other than the above	 P.41 "Copying on other than the above standard sizes of paper"
Others (Non-standard sizes)		 P.44 "Bypass copying on non-standard size paper"

Tips

- Bypass copying stops when the paper placed on the bypass tray runs out during copying, even if the paper of the same size is in any of the drawers. Copying restarts when paper is supplied to the bypass tray.
- When bypass copying has been completed, the [FUNCTION CLEAR] button on the control panel blinks. Press this button to switch bypass copying to normal copying using the drawers.
 (Even if you do not press the [FUNCTION CLEAR] button, the bypass copying mode will be cleared when the automatic function clear mode kicks in after a specified period of time.)

■ Bypass copying on standard size paper

- Copying on A3, A4, B4 and B5 size paper (in equipment other than for North America) / LD, LT, LG and ST-R size paper (in equipment for North America)

1 Place the original(s).

2 Place paper with its copy side down on the bypass tray. Then align the side guides to the paper length while holding the tab.

When paper is placed, the menu for bypass copying appears.

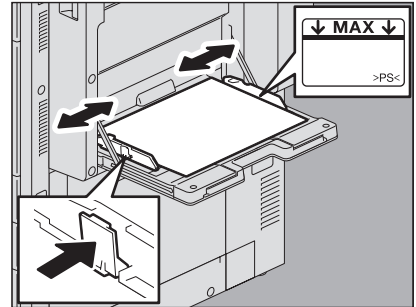

Notes

- The height of the paper must not exceed the indicator on the side guides.
- When you use more than one sheet of paper, fan the sheets well before placing them on the bypass tray. Be careful not to cut your fingers when fanning.
- Do not push paper into the entrance of the bypass feeder. This could cause a paper misfeed.

3 Select the same size button under “COPY” as that of the paper you placed on the bypass tray.

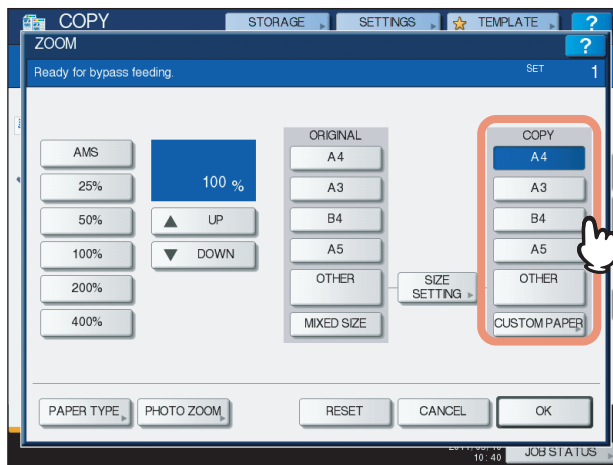

The paper size is now set.

Note

If the paper size is not selected in this step, copying may be slowed down.

4 Press [PAPER TYPE].

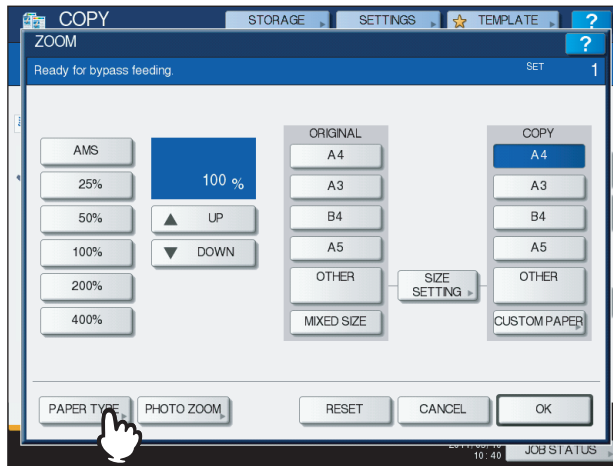

2

5 Press the button of the same paper type as the paper you placed on the bypass tray. Then press [OK].

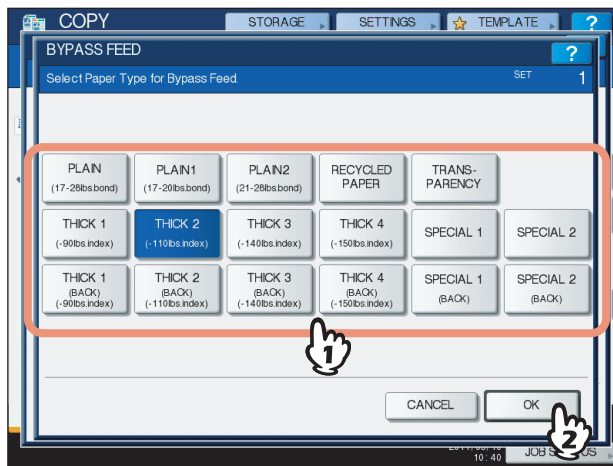

Notes

- If you select a wrong paper type, this could cause a paper misfeed or significant image trouble.
- When you select a paper type, you can confirm it with the icons displayed on the equipment status indication area as shown below.

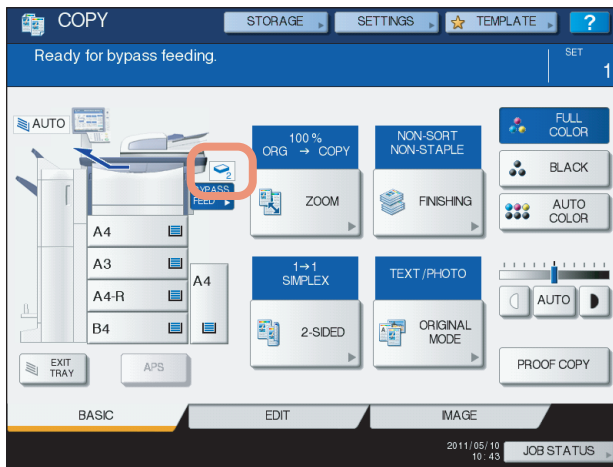

Paper type	Icon	Paper type	Icon
PLAIN	—	THICK 4	
		THICK 4 (BACK)	
PLAIN 1		TRANSPARENCY	
PLAIN 2		RECYCLED PAPER	
THICK 1		SPECIAL 1	
THICK 1 (BACK)		SPECIAL 1 (BACK)	
THICK 2		SPECIAL 2	
THICK 2 (BACK)		SPECIAL 2 (BACK)	
THICK 3			
THICK 3 (BACK)			

About "BACK"

When you make 2-sided copies on particular paper types such as THICK 4, to which automatic 2-sided copying cannot be applied, select a paper type for one side and make a copy of it, and then select "(BACK)" of the same paper type for the other side.

Example: When making a 2-sided copy on THICK 4 paper

1. Place paper on the bypass tray.
2. Select "THICK 4" for the paper type and start copying.
3. Place the paper copied in step 2 on the bypass tray again with its copied side up.
4. Select "THICK 4 (BACK)" and start copying.

Notes

- Automatic 2-sided copying can be applied to plain paper, recycled paper, THICK 1, THICK 2, THICK 3, SPECIAL 1 and SPECIAL 2.
- 2-sided copying cannot be applied to sheets of OHP film (TRANSPARENCY).

6 After setting the paper size and type, press [OK].

The menu returns to the BASIC menu.

7 Select other copy modes as required, and then press the [START] button on the control panel.

Note

When you copy on sheets of OHP film, remove the copied OHP film one sheet at a time as they exit onto the receiving tray. If the sheets of OHP film pile up, they may get curled and may not be projected properly.

2

□ Copying on other than the above standard sizes of paper

1 Place the original(s) and paper in the same procedure noted in steps 1 and 2 in “Copying on A3, A4, B4 and B5 size paper (in equipment other than for North America) / LD, LT, LG and ST-R size paper (in equipment for North America)” (P.38)

2 Press [SIZE SETTING] on the touch panel.

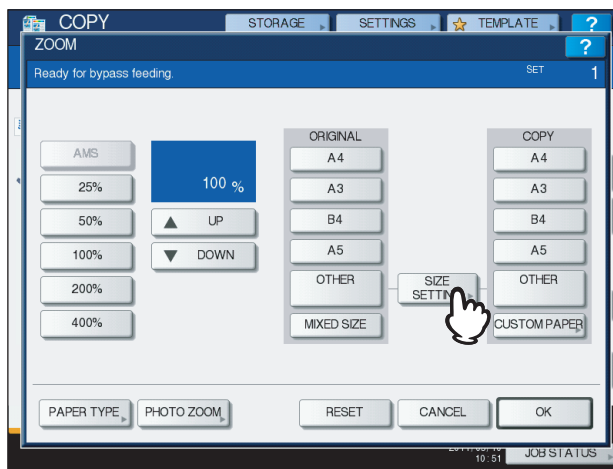

3 Press the button of the same size as the paper you placed on the bypass tray.

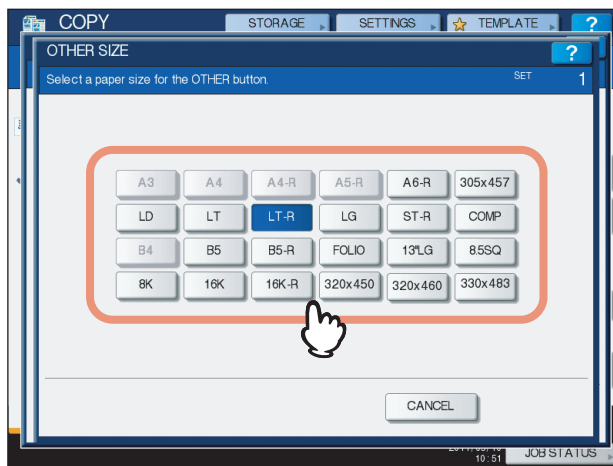

The selected size will be registered as an “OTHER” size.

4 Press [OTHER] under “COPY”.

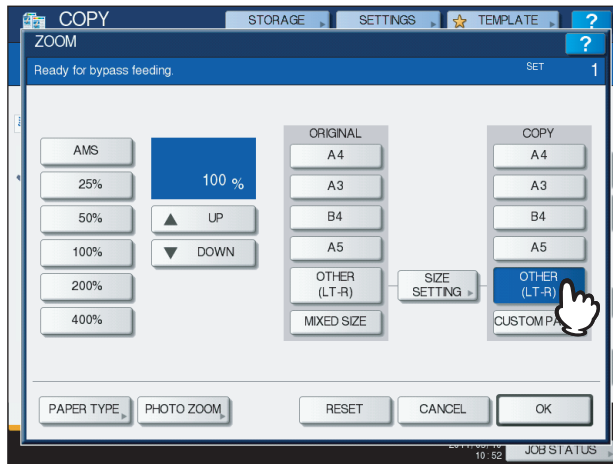

The paper size is now set to the one registered as “OTHER” size.

Note

If the paper size is not selected in this step, copying may be slowed down.

5 Press [PAPER TYPE].

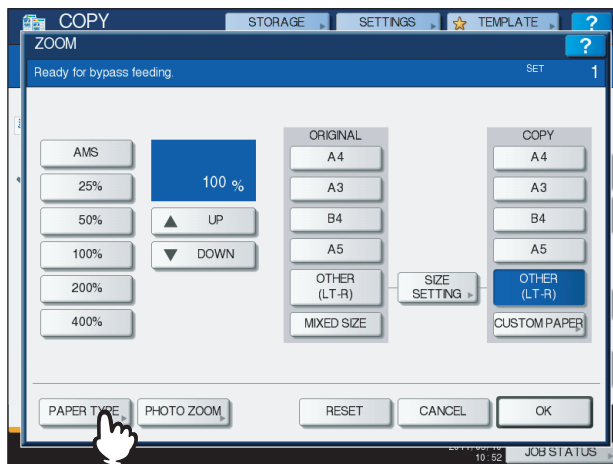

- 6 Press the button of the same paper type as the paper you placed on the bypass tray. Then press [OK].**

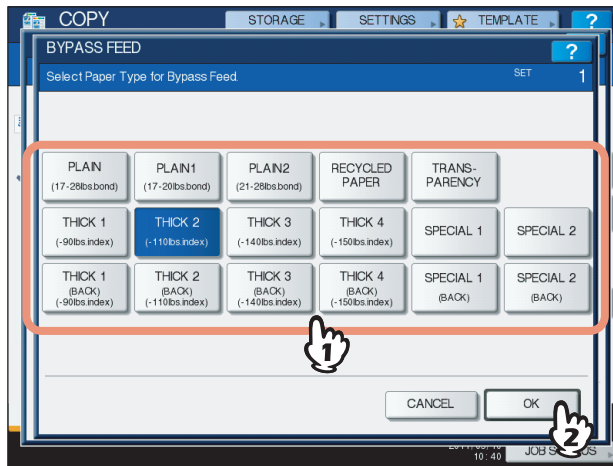

2

Notes

- If you select a wrong paper type, this could cause a paper misfeed or significant image trouble.
- When you select a paper type, you can confirm it with the icons displayed on the equipment status indication area. For details, see the following page:
Table in step 5 in "Copying on A3, A4, B4 and B5 size paper (in equipment other than for North America) / LD, LT, LG and ST-R size paper (in equipment for North America)" (P.38)

- 7 After setting the paper size and paper type, press [OK].**
The menu returns to the BASIC menu.

- 8 Select other copy modes as required, and then press the [START] button on the control panel.**

■ Bypass copying on non-standard size paper

You can use non-standard size paper within the sizes shown on the right.

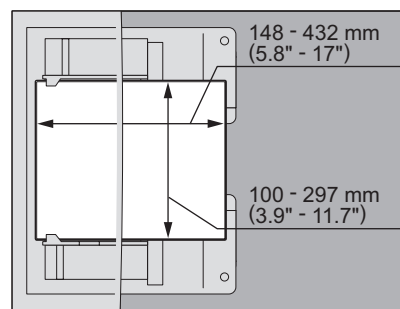

- 1** Place the original on the original glass.
- 2** Place paper with its copy side down on the bypass tray. Then align the side guides to the paper length while holding the tab.

When paper is placed, the menu for bypass copying appears.

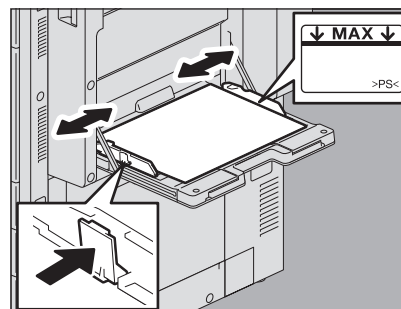

Notes

- The height of the paper must not exceed the indicator on the side guides.
- When you use more than one sheet of paper, fan the sheets well before placing them on the bypass tray. Be careful not to cut your fingers when fanning.
- Do not push paper into the entrance of the bypass feeder. This could cause a paper misfeed.

- 3** Press [CUSTOM PAPER] on the touch panel.

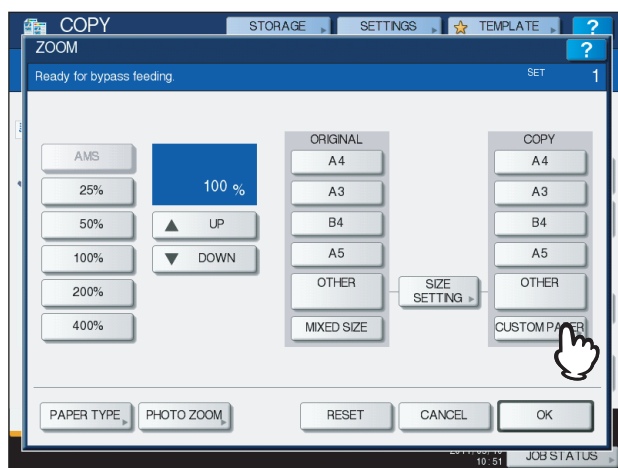

4 Key in the dimension.

- 1) Press [Length] and key in the value. (100 mm (3.94") to 297 mm (11.69"))
- 2) Press [Width] and key in the value. (148 mm (5.83") to 432 mm (17.01"))
- 3) Press [OK].

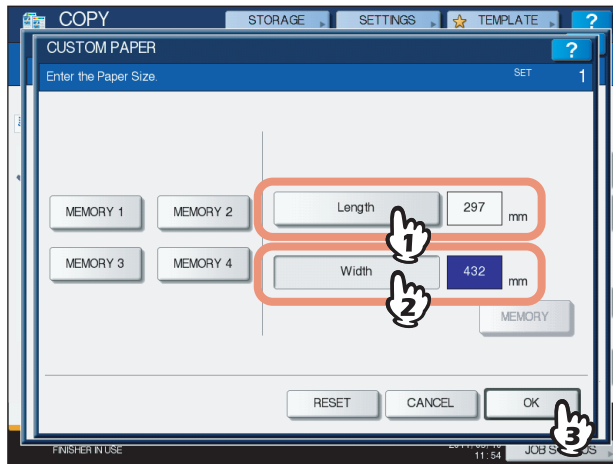

Length and width are indicated as shown on the right:

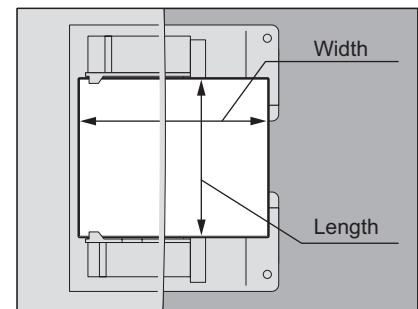

To call up the dimension data registered previously, press the desired button from [MEMORY 1] to [MEMORY 4], and then press [OK].

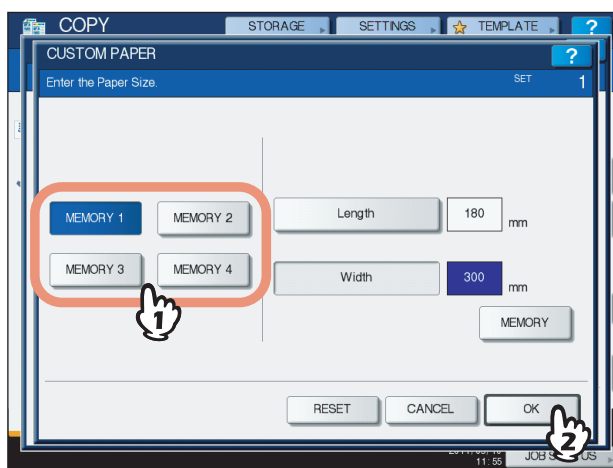

Tip

To register dimension data into the memory, see the following page:
 P.46 "Registering non-standard size in the memory"

5 Select other copy modes as required, and then press the [START] button on the control panel.

□ Registering non-standard size in the memory

1 Follow the same procedure noted in steps 1 to 3 in “Bypass copying on non-standard size paper” (P.44).

2 Register dimensions.

- 1) Select a desired memory number.
- 2) Press [Length] and key in the value. (100 mm to 297 mm (3.94" to 11.69"))
- 3) Press [Width] and key in the value. (148 mm to 432 mm (5.83" to 17.01"))
- 4) Press [MEMORY].

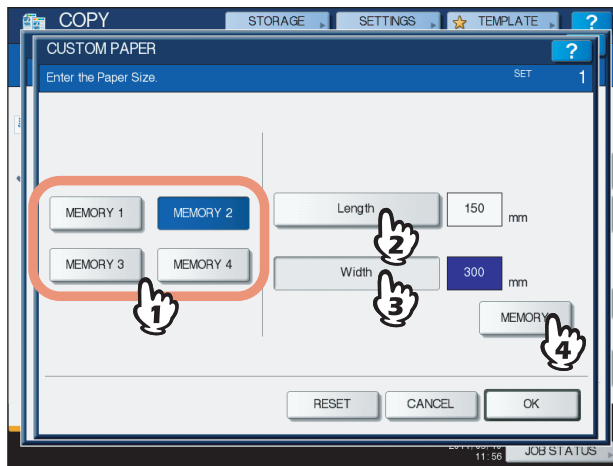

BASIC COPY MODES

This chapter describes the basic copying functions including how to change the reproduction ratio, how to set sorting modes or how to perform duplex copying.

Before Using Copying Functions	48
Default settings.....	48
Confirming the set functions.....	48
Clearing the set functions.....	49
Restrictions on function combinations.....	49
Paper Selection	50
Automatic Paper Selection (APS)	50
Selecting desired paper manually	51
Copying mixed-size originals in one operation.....	52
Switching Color Modes.....	54
Setting Original Modes	55
Density Adjustment.....	56
Enlargement and Reduction Copying	57
Automatic Magnification Selection (AMS)	57
Specifying both the original size and the copy paper size separately	59
Specifying reproduction ratio manually.....	61
Copying photo originals in the optimal reproduction ratio for copy paper size (PHOTO ZOOM)	63
Selecting Finishing Mode	66
Finishing modes and optional finishing devices	66
Sort/Group mode.....	68
Rotate sort mode.....	69
Staple sort mode	70
Magazine sort / Center fold / Saddle stitch.....	72
Hole punch mode	75
Manual staple mode	76
Duplex Copying	77
Making a 1-sided copy	78
Making a 2-sided copy	79
Making a 2-sided copy from a book-type original.....	80
Performing Copy & File	82
Setting share folder	84

Before Using Copying Functions

■ Default settings

This equipment is under its “default settings” when the power is turned ON, namely, if no setting change has been applied yet, the equipment’s settings return to the default ones when the energy saving mode is cleared or the [FUNCTION CLEAR] button on the control panel is pressed. The default settings for basic copy modes at installation are shown below.

Item	Default setting
Reproduction ratio	100%
Copy quantity	1
Paper selection	Automatic Paper Selection (APS)
Simplex/Duplex	1-sided original -> 1-sided copy
Density adjustment	Manual adjustment
Color mode	FULL COLOR
Original mode	TEXT/PHOTO
Finishing mode	When using the original glass: NON-SORT NON-STAPLE When using the RADF (Reversing Automatic Document Feeder): SORT
Feeding mode when using the RADF	Continuous feed mode

The default settings are changeable. For details, refer to the *MFP Management Guide*.

■ Confirming the set functions

If you press [SETTINGS] on the touch panel, the menu shown below is displayed. On this menu, you can view the functions that are currently set.

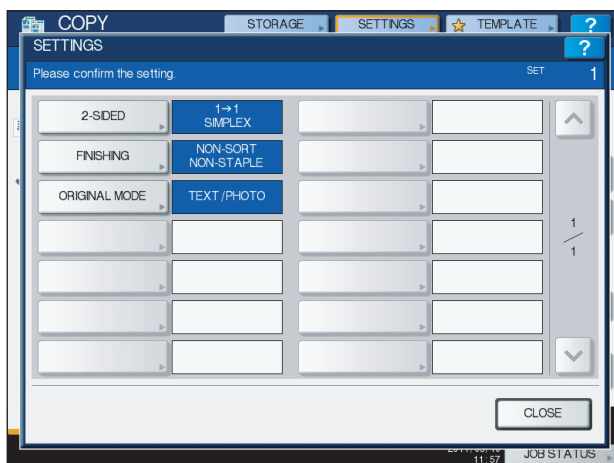
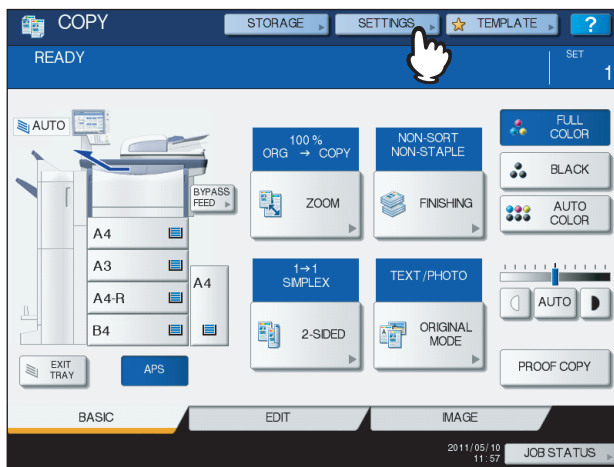

Switching to the function setting menu

To change the functions on the current menu, press the corresponding buttons. The desired setting menu will then appear.

■ Clearing the set functions

If you want to clear any copy function setting, press [RESET] on the corresponding setting menu. However, for FULL IMAGE on the EDIT menu, also press the highlighted button to clear the setting.
 P.87 “EDITING FUNCTIONS”

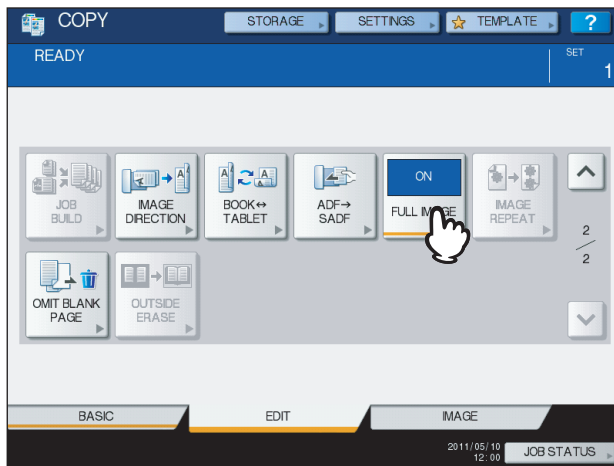

Clearing all settings changed

When you press the [FUNCTION CLEAR] button on the control panel, all the function changes will be cleared. Even if you do not do so, the changes will be cleared if the equipment is left idle for 45 sec. (default setting). For how to change this period, refer to the *MFP Management Guide*.

■ Restrictions on function combinations

Several copy functions can be used together. However some functions may not be used with other ones. For details, see the following pages:



- P.177 “Copying Function Combination Matrix”
- P.179 “Image Adjustment Function Combination Matrix”

Paper Selection

Automatic Paper Selection (APS)

This equipment detects the size of an original and selects paper of the same size automatically. This function is called Automatic Paper Selection (APS).

Tips

- For the original sizes detectable, see the following page:
 P.25 “Acceptable originals”
- Some original sizes may not be detected with this function. In this case, select the desired size manually.
 P.51 “Selecting desired paper manually”

- 1 Place paper in the drawer(s).**
- 2 Place the original(s).**
- 3 Press [APS] on the touch panel.**



The paper selection mode is now set at Automatic Paper Selection.

Tips

- The paper selection mode is set at Automatic Paper Selection by default.
- Even if the direction of the paper placed in the selected drawer differs from that of the original, this equipment rotates the data of the original by 90 degrees to make copies as long as their sizes are the same. (This works on A4, B5 or LT paper only.) For example, when an A4 original is placed in a portrait direction and A4-R paper is placed in the drawer, the data of the A4 original will be rotated and copied correctly on A4-R paper.

Note

If “Change direction of original” or “CHANGE DRAWER TO CORRECT PAPER SIZE” appears, follow the directions.

- 4 Select other copy modes as required, and then press the [START] button on the control panel.**

■ Selecting desired paper manually

You need to select paper by yourself when copying the following originals whose sizes cannot be detected correctly:

- Highly transparent originals (e.g. OHP film, tracing paper)
- Totally dark originals or originals with dark borders
- Non-standard size originals (e.g. newspapers, magazines)

Tip

When paper of the size you want to use is not in any drawer, place it in a drawer or on the bypass tray.

📖 P.13 "Placing paper in drawers"

📖 P.37 "Bypass Copying"

1 Place paper in the drawer(s).

When using bypass copying, be sure to set the paper size.

2 Place the original(s).

3 Press the drawer button corresponding to the desired paper size.

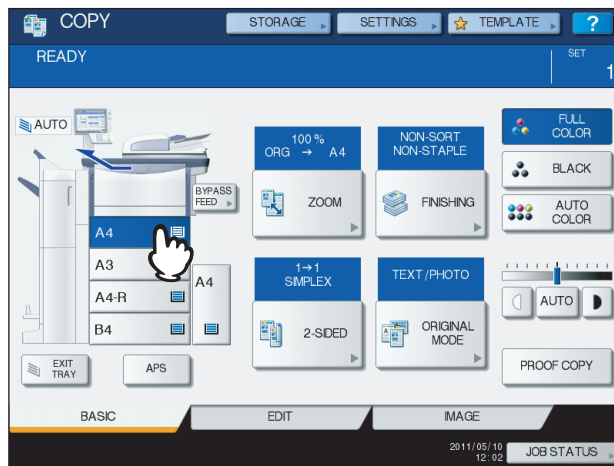

4 Select other copy modes as required, and then press the [START] button on the control panel.

■ Copying mixed-size originals in one operation

You can copy a set of originals whose sizes are individually different, using the RADF (Reversing Automatic Document Feeder).

The original sizes that can be mixed are as follows:

North America: LD, LG, LT, LT-R, COMP

Other than North America: A3, A4, A4-R, B4, B5, FOLIO

1 Place paper in the drawer(s).

The bypass tray cannot be used. Use the drawers.

2 Adjust the side guides to the widest original, and then align the originals against the side guide on the front side.

When original widths are the same

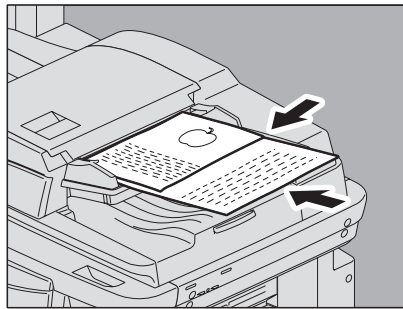

When original widths are not the same

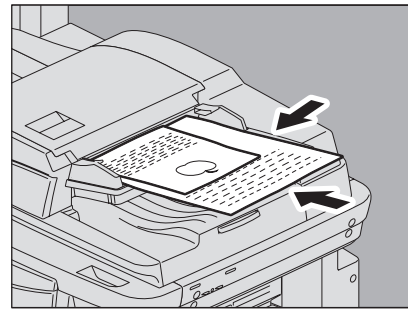

Note

When copying originals of different widths, the copied image of the smaller one may be skewed because it does not touch the side guide on the rear side.

3 Press [ZOOM] on the touch panel.

4 Press [MIXED SIZE].

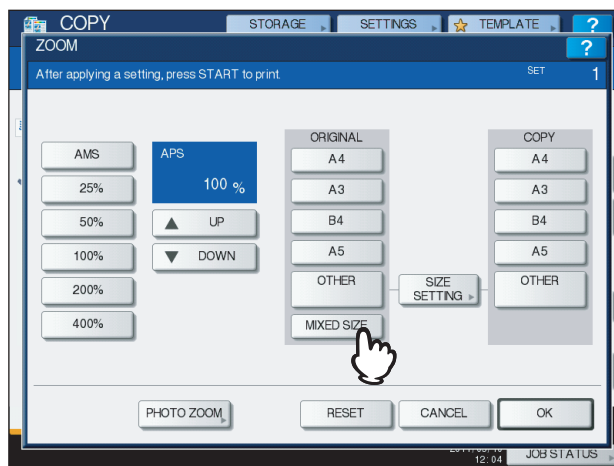

5 Press [AMS] to make copies on paper in one size. To make copies on paper of the same size as the originals, press [OK] or [CANCEL] so that the menu returns to the BASIC menu, and then press [APS].

When [AMS] is selected:

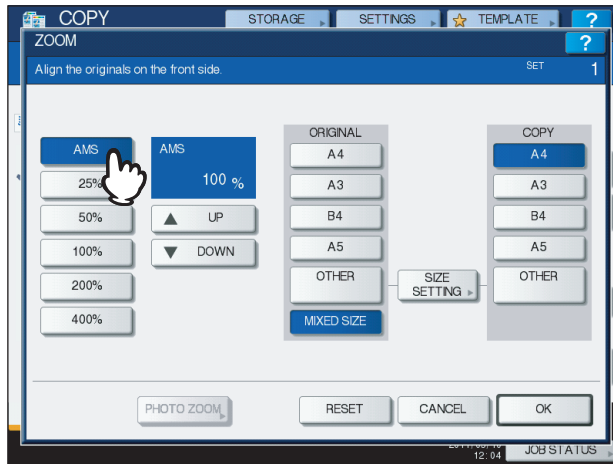

Notes

- In the Automatic Magnification Selection, copy images cannot be enlarged from A4 (portrait), B5 (portrait) or LT (portrait) to A3 (landscape), B4 (landscape), LD (landscape) or LG (landscape). In this case, place A4, B5 or LT originals in a landscape direction.
- Before you use Automatic Paper Selection, be sure that all paper sizes corresponding to the original sizes have been placed in the drawers.

6 Select other copy modes as required, and then press the [START] button on the control panel.

Note

If “Change direction of original” appears while scanning is in progress, remove the original from the RADF and change its direction accordingly.

Switching Color Modes

You can switch the color mode. There are 3 color modes as shown below.

FULL COLOR: All originals are copied in full colors. (Default)

BLACK: All originals are copied in black and white.

AUTO COLOR: The equipment automatically judges the type of each color on originals. Colored originals are copied in full colors and black-and-white originals are copied in black and white.

Switching color modes

Press any of [FULL COLOR], [BLACK] or [AUTO COLOR] on the touch panel.



Note

When you select [AUTO COLOR], some originals may not be copied exactly as they look, such as the cases shown below. Select either [FULL COLOR] or [BLACK].

- **When color originals are copied in black**
Example:
 - Originals whose colored area is extremely small
 - Originals which are completely black
 - Originals whose colors are light
- **When black originals are copied in full colors**
Example:
 - Yellowish originals
 - Originals with a colored background

Tip

The sensitivity to detect whether the data scanned in auto color are color or black can be changed. For details, refer to the **MFP Management Guide**.

Setting Original Modes

You can make copies with the optimal image quality by selecting the following modes for your original. The selectable original mode differs depending on the color mode as shown in the table below. Select the color mode first, and then the original mode.

Original mode	Description	Color mode		
		FULL COLOR	BLACK	AUTO COLOR
TEXT/PHOTO	Originals with text and photographs mixed	Yes	Yes	Yes
TEXT	Originals with text (or text and line art) only	Yes	Yes	Yes
PRINTED IMAGE	Originals with photogravure (e.g. magazine, brochure)	Yes	—	Yes
PHOTO	Originals with general photographs on photographic printing paper	Yes	—	—
	Originals with photographs	—	Yes	—
MAP	Originals with fine illustrations or text	Yes	—	—
IMAGE SMOOTHING	Originals with text and photographs mixed (especially originals requiring higher reproducibility on photos)	—	Yes	—

Tip

TEXT/PHOTO is set by default. The default setting can be changed in each color mode. For details, refer to the **MFP Management Guide**.

1 Press [ORIGINAL MODE] on the touch panel.

2 Select the original mode, and then press [OK].

The selectable original modes differ depending on the color modes currently set.

Example: When the color mode is "FULL COLOR"

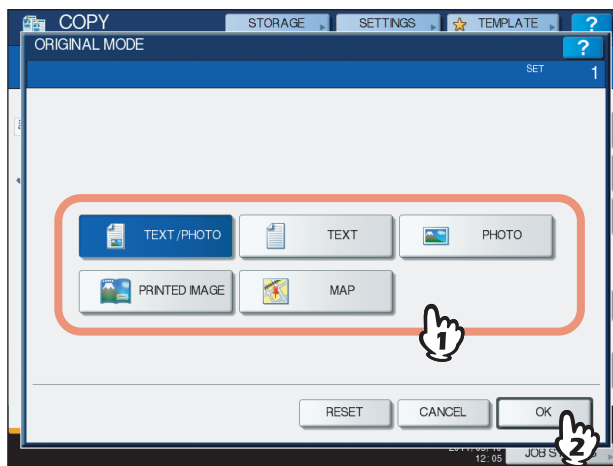

Density Adjustment

This equipment detects the density level of originals and automatically adjusts the density level of the copied image to the optimal one. Alternatively, you can manually adjust it to the desired level.

Adjusting automatically (automatic density adjustment)

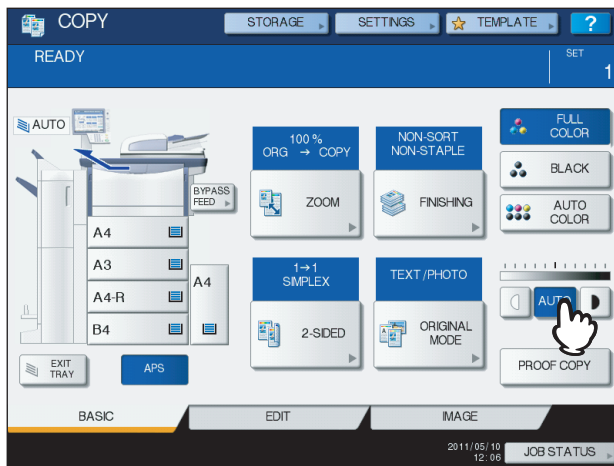

Press [AUTO] on the touch panel.



Tip

The default setting of the automatic density adjustment is as follows according to the color modes:
FULL COLOR or AUTO COLOR: OFF
BLACK: ON

Adjusting manually

Press either  or  to select the desired density level.

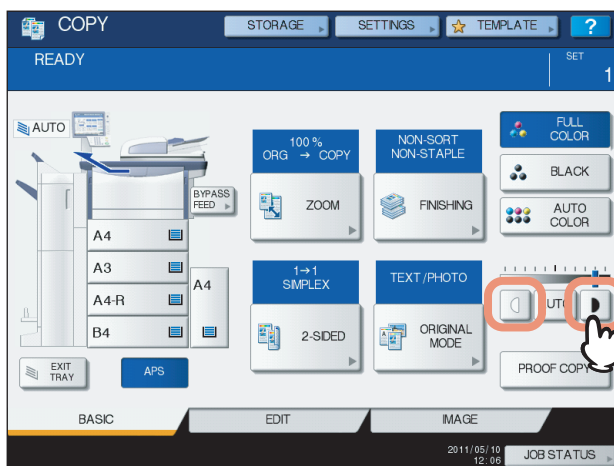

Enlargement and Reduction Copying

You can change the reproduction ratio of copied images in the following procedures:

Automatic Magnification Selection (AMS):

You need to specify the copy paper size in advance. Then this equipment will detect the original size and automatically select the optimal reproduction ratio for the copy paper size.

Specifying both original size and copy paper size separately:

You need to specify both the original size and the copy paper size separately in advance. According to the sizes you specified, the optimal reproduction ratio is selected automatically. This feature is used when Automatic Magnification Selection is not available, such as when copying OHP film originals.

Specifying reproduction ratio manually:

You can select the desired reproduction ratio by pressing [ZOOM] or one-touch zoom buttons on the touch panel.

Copying photo originals in the optimal reproduction ratio for copy paper size (PHOTO ZOOM)

You can copy photo originals in the reproduction ratio best suited to the copy paper size.

Tip

The available range of reproduction ratio differs depending on whether the original is placed on the original glass or on the RADF (Reversing Automatic Document Feeder).

Original glass: 25 to 400%

RADF: 25 to 200%

■ Automatic Magnification Selection (AMS)

Specify the copy paper size in advance so that this equipment will detect the original size and automatically select the optimal reproduction ratio to the copy paper size.

This function is available when the size of the originals is as follows:

North America: LD, LG, LT, LT-R, ST-R and COMP (COMP is available only when the RADF is used.)

Other than North America: A3, A4, A4-R, A5-R, B4, B5, B5-R, FOLIO (FOLIO is available only when the RADF is used.)

Note

This function does not work properly for the originals noted below. Select other methods when copying them.

- Highly transparent originals (e.g. OHP film, tracing paper)
- Totally dark originals or ones with dark borders
- Non-standard size originals (e.g. newspapers, magazines)

- 1 Place paper in the drawer(s).
- 2 Press [ZOOM] on the touch panel.

3 Select the desired paper size, press [AMS] and then [OK].

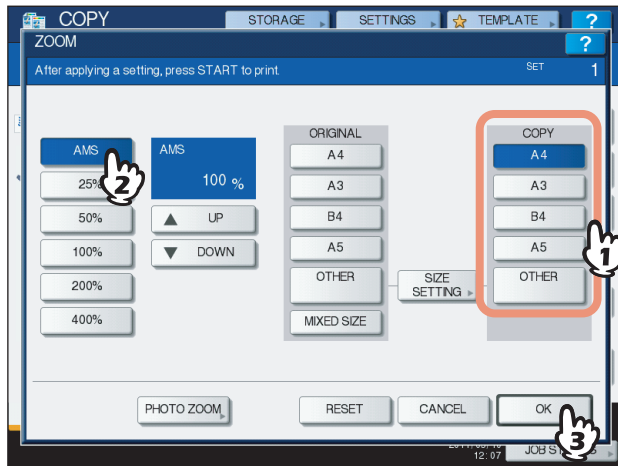

Tips

- If you want to select a paper size other than the following, you need to register the size as "OTHER". Once you register this size, it will be specified every time you press [OTHER] on the touch panel.
North America: LD, LG, LT, ST
Other than North America: A3, A4, B4, B5
For how to register, see the following page:
 P.60 "Registering paper sizes to "OTHER" size"
- Paper sizes can also be registered by pressing the desired drawer button of the equipment status indication area on the BASIC menu.

4 Place the original(s).

If the original is placed on the original glass, the reproduction ratio is set when the original is placed. If the original is placed on the RADF, the reproduction ratio is set when the original is scanned.

Note

If "Change direction of original" appears, change it accordingly.

5 Select other copy modes as required, and then press the [START] button on the control panel.

■ Specifying both the original size and the copy paper size separately

- 1 Place paper in the drawer(s).
- 2 Place the original(s).
- 3 Press [ZOOM] on the touch panel.
- 4 Select the desired sizes for the original and copy paper, and then press [OK].

3

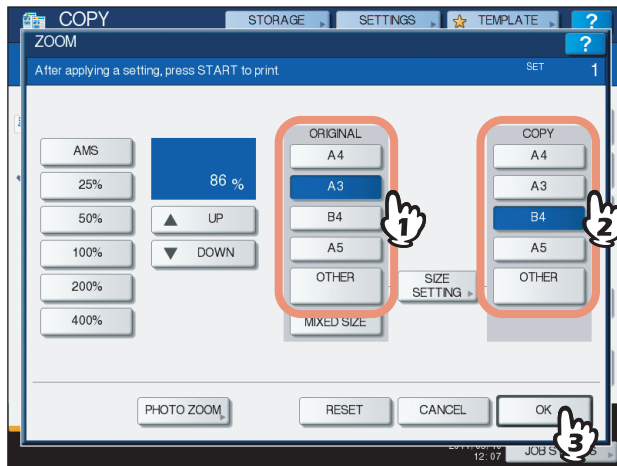

Tips

- If you want to select a size other than the following for the original size and copy paper size, you need to register the size as "OTHER". Once you register this size, it will be specified every time you press [OTHER] on the touch panel.
 North America: LD, LG, LT, ST
 Other than North America: A3, A4, B4, B5
 For how to register, see the following page:
 📖 P.60 "Registering paper sizes to "OTHER" size"
- Paper sizes can also be registered by pressing the desired drawer button of the equipment status indication area on the BASIC menu.

- 5 Select other copy modes as required, and then press the [START] button on the control panel.

□ Registering paper sizes to “OTHER” size

If you want to select a size other than the following for the original size and copy paper size, you need to register the size as “OTHER” following the procedures below. Once you register this size, it will be specified every time you press [OTHER] on the touch panel.

North America: LD, LG, LT, ST

Other than North America: A3, A4, B4, B5

Note

You can register only standard sizes as [OTHER] and cannot register any non-standard sizes.

1 Press [SIZE SETTING] on the touch panel.

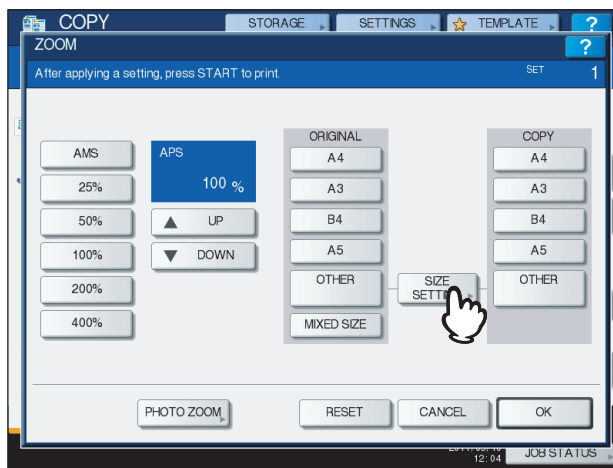

2 Select the desired size.

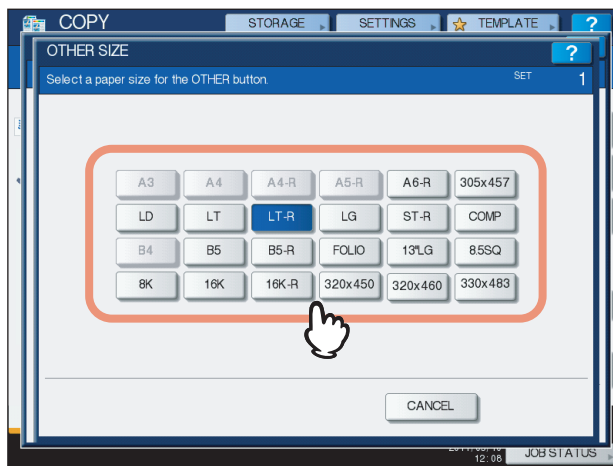

The selected size will be registered as an “OTHER” size.

■ Specifying reproduction ratio manually

- 1 Place paper in the drawer(s).
- 2 Place the original(s).
- 3 Press [ZOOM] on the touch panel.
- 4 Press the buttons below to select the desired reproduction ratio.

[▲UP] and [▼DOWN] buttons

The reproduction ratio changes by 1% every time either of them is pressed. When you hold either down, the ratio goes up or down automatically.

One-touch zoom buttons

Select the desired ratio from [400%], [200%], [100%], [50%] and [25%].

Note

When the RADF is used, the maximum ratio available is 200%.

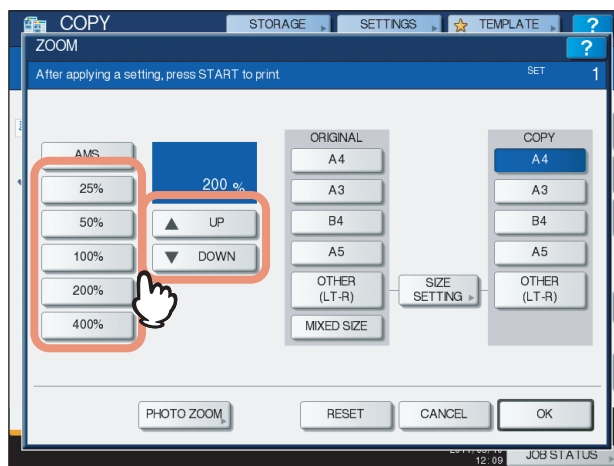

5 Select the desired size, and then press [OK].

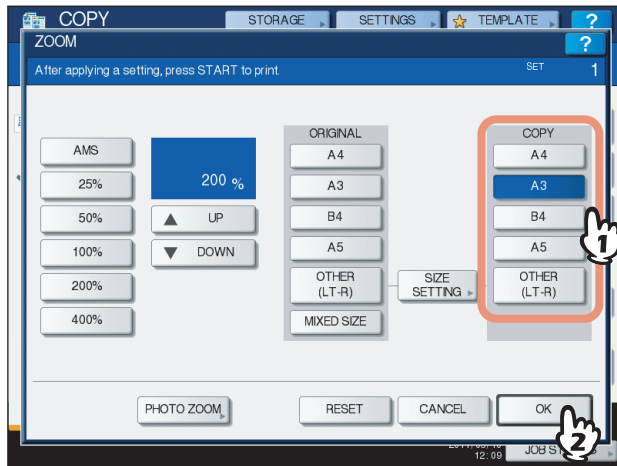

Tips

- If you want to select a paper size other than the following, you need to register the size as "OTHER". Once you register this size, it will be specified every time you press [OTHER] on the touch panel.
North America: LD, LG, LT, ST
Other than North America: A3, A4, B4, B5
For how to register, see the following page:
📖 P.60 "Registering paper sizes to "OTHER" size"
- Paper sizes can also be registered by pressing the desired drawer button of the equipment status indication area on the BASIC menu.

6 Select other copy modes as required, and then press the [START] button on the control panel.

■ Copying photo originals in the optimal reproduction ratio for copy paper size (PHOTO ZOOM)

- 1 Place paper in the drawer(s).
- 2 Place the original on the original glass in a landscape direction.
- 3 Press [ZOOM] on the touch panel.



- 4 Press [PHOTO ZOOM].

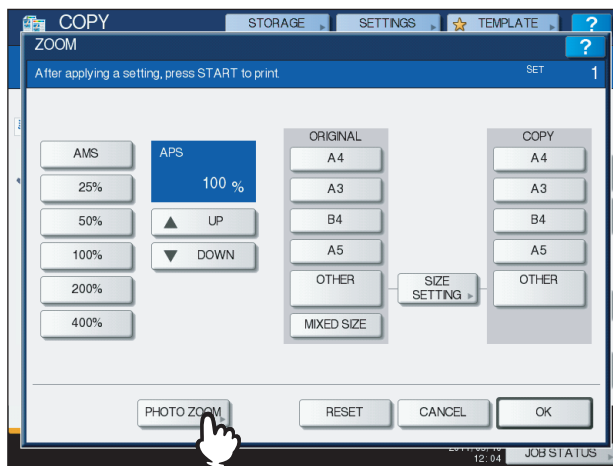

5 Select the original size.

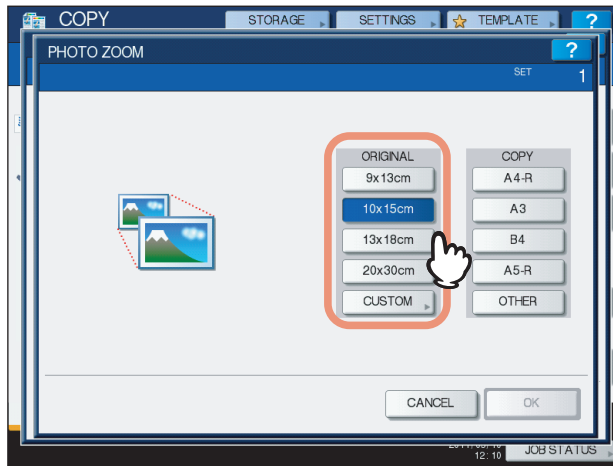

Note

The actual size for the [3" x 5"] button is 3.5" x 5.0".

Tip

When the size of the original is other than the ones below, key in the dimension of the original manually.

North America: 3" x 5", 4" x 6", 5" x 7" or 8" x 10"

Other than North America: 9 x 13 cm, 10 x 15 cm, 13 x 18 cm or 20 x 30 cm

P.65 "Setting photo originals in other sizes"

6 Select the desired copy paper size, and then press [OK].

Note

If you want to select a paper size other than the following, you need to register the size as "OTHER" size. In this case, register it in a landscape direction. Once you register this size, it will be specified every time you press [OTHER] on the touch panel.

North America: LD, LG, LT, ST

Other than North America: A3, A4, B4, A5

For how to register it, see the following page:

P.60 "Registering paper sizes to "OTHER" size"

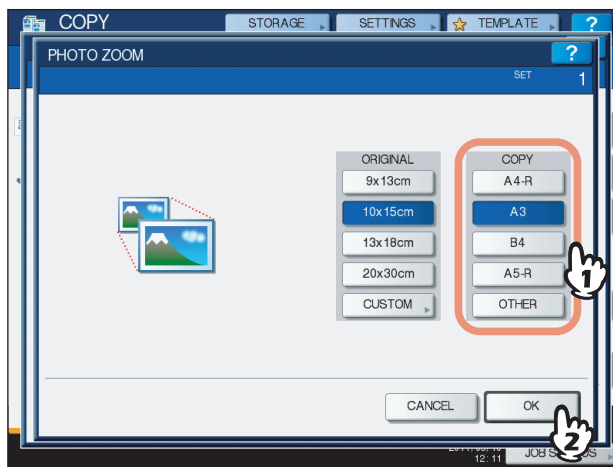

7 Select other copy modes as required, and then press the [START] button on the control panel.

If "NON-SORT NON-STAPLE" is selected as a sorting mode, scanning of the original starts. If another sorting mode is selected, follow the procedure below.

8 Place the next original, and then press [NEXT COPY] on the touch panel or the [START] button on the control panel.

Scanning of the next original starts. If you have more than one original, repeat this step until the scanning of all the originals is finished.

9 When the scanning of all the originals is finished, press [JOB FINISH] on the touch panel.

Copying starts.

3

□ Setting photo originals in other sizes

1 Press [CUSTOM] on the touch panel.

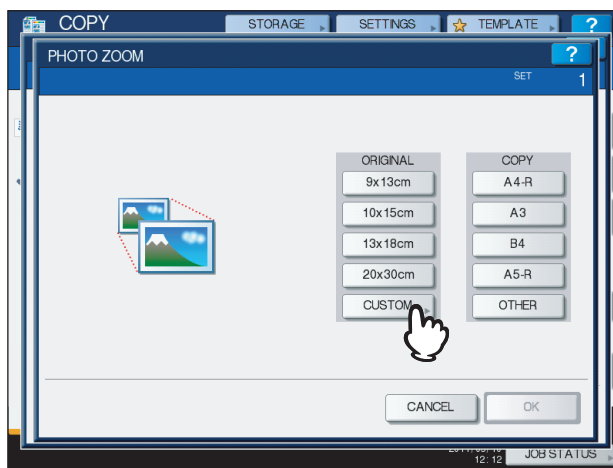

2 Key in the size of the original.

- 1) Press [X] on the touch panel and key in its width within 10 to 434 mm (0.39" to 17.09").
- 2) Press [Y] on the touch panel and key in its length within 10 to 300 mm (0.39" to 11.81").
- 3) Press [OK] on the touch panel.

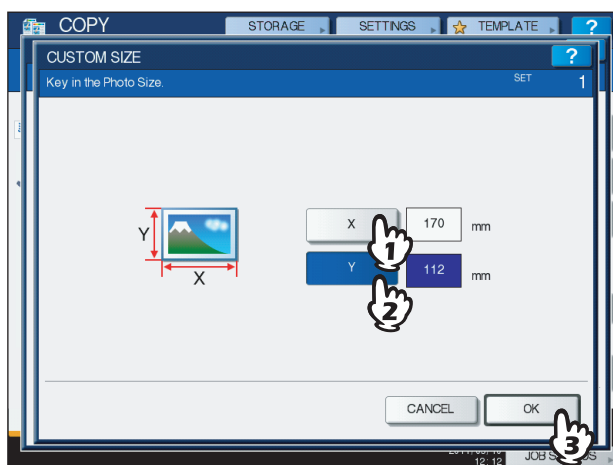

Selecting Finishing Mode

■ Finishing modes and optional finishing devices

See the table below for each finishing mode.

Finishing mode	Description
Non-sort Non-staple	Copies exit without being sorted or stapled.
Sort (P.68)	Copies exit in the same page order as the originals one set after another.
Group (P.68)	Copies grouped by page exit.
Rotate sort (P.69)	Copies exit set by set alternately in a different direction.
Staple sort (P.70)	Copies exit with their corner stapled.
Magazine sort (P.72)	Copies exit in a book-type page order.
Center fold (P.72)	Copies exit in a book-type page order with their center folded.
Saddle stitch (P.72)	Copies exit in a book-type page order with their center folded and stapled.
Magazine sort & center fold (P.72)	Magazine sort and center fold are used together.
Magazine sort & saddle stitch (P.72)	Magazine sort and saddle stitch are used together.
Hole punch (P.75)	Copies exit with their side punched.
Manual staple (P.76)	Copies are stapled manually.

The available finishing modes differ depending on the type of optional finishing devices (Finisher and Hole Punch Unit) installed. Finishing devices available for this equipment are as follows:

Finisher

- Finisher MJ-1103
- Saddle Stitch Finisher MJ-1104

Hole Punch Unit

Hole Punch Unit MJ-6102

Check the finishing modes enabled with each finishing device.

Finishing mode	Devices				
	MJ-1103 & MJ-6102	MJ-1103	MJ-1104 & MJ-6102	MJ-1104	No device
Non-sort Non-staple	Yes	Yes	Yes	Yes	Yes
Sort	Yes	Yes	Yes	Yes	Yes
Group	Yes	Yes	Yes	Yes	Yes
Rotate sort	Yes	Yes	Yes	Yes	Yes
Staple sort	Yes	Yes	Yes	Yes	—
Magazine sort	Yes	Yes	Yes	Yes	Yes
Center fold	—	—	Yes	Yes	—
Saddle stitch	—	—	Yes	Yes	—
Magazine sort & center fold	—	—	Yes	Yes	—
Magazine sort & saddle stitch	—	—	Yes	Yes	—
Hole punch	Yes	—	Yes	—	—
Manual staple	Yes	Yes	Yes	Yes	—

□ Name of each part of the Finisher (optional)

MJ-1103

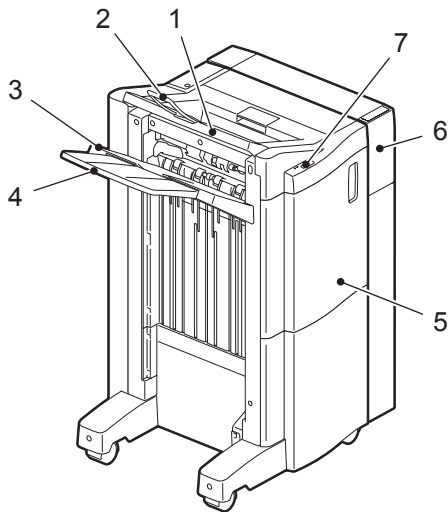

1. Upper receiving tray
2. Tray holder
3. Lower receiving tray
4. Sub-tray
5. Front cover
6. Hole Punch Unit MJ-6102
7. Stapling control section

MJ-1104

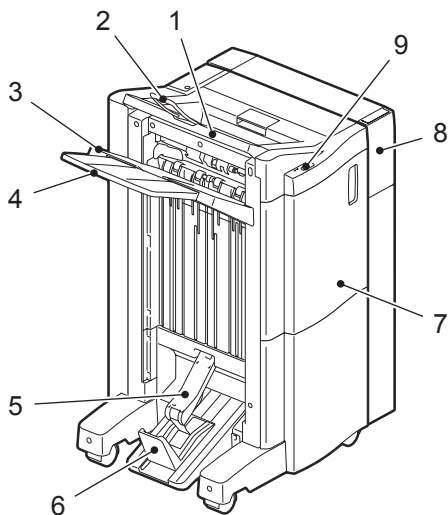

1. Upper receiving tray
2. Tray holder
3. Lower receiving tray
4. Sub-tray
5. Saddle stitch tray
6. Stopper
7. Front cover
8. Hole Punch Unit MJ-6102
9. Stapling control section

Using the tray holder

Open the tray holder when the length of the paper in the exit direction is longer than A3 or LD size. The holder prevents paper, which has exited, from falling. Return it to its original position after use.

Note

For consistent paper exiting, make sure you return the tray holder to its original position when using A3/LD size paper or smaller.



Sort/Group mode

When you make more than one set of copies, they can be made to exit in the same page order as that of the originals. This mode is called the sort mode. Copies can also be made to exit grouped by page. This mode is called the group mode.

Sort mode

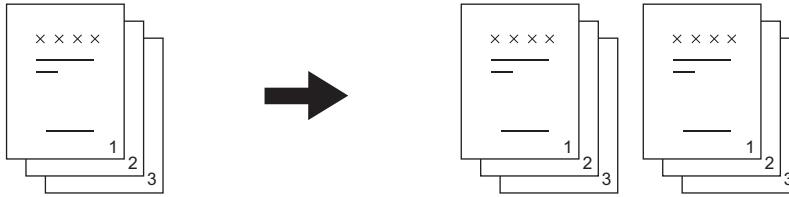

Group mode

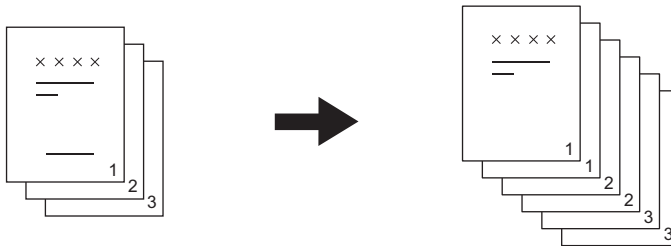

Tip

When you use large-size paper, such as A3, B4, LD and LG, pull out the sub-tray in advance so that the copied paper will not fall off and will be sorted neatly.

- 1 Place paper in the drawer(s).
 - 2 Place the original(s).
- Tip
- When you place originals on the RADF (Reversing Automatic Document Feeder), the display of the sorting mode button will change to "SORT".
- 3 Press [FINISHING] on the touch panel.
 - 4 Select [SORT] or [GROUP], and then press [OK].

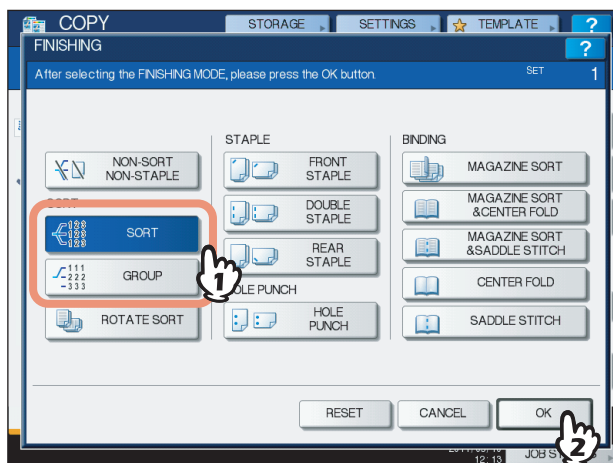

5 Key in the desired number of copies.

6 Select other copy modes as required, and then press the [START] button on the control panel.

■ Rotate sort mode

When you make more than one set of copies, one set can be made to exit on top of another set, alternating in portrait and landscape directions. This mode is called the rotate sort mode. Use 2 drawers and 2 stacks of paper of the same size. Place one stack of paper in one drawer in a portrait direction and place the other in another drawer in a landscape direction before you start copying.

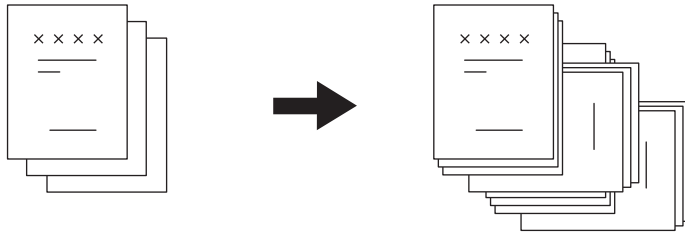

Notes

- A4, B5 and LT sized paper placed on the drawer or bypass tray can be used.
- The rotate sort mode is not available when Automatic Paper Selection is selected.

1 Place paper in the drawer(s).

Tip

Place one stack of paper in one drawer in a portrait direction and place the other in another drawer in a landscape direction.

2 Place the original(s).

3 Press [FINISHING] on the touch panel.

4 Select [ROTATE SORT], and then press [OK].

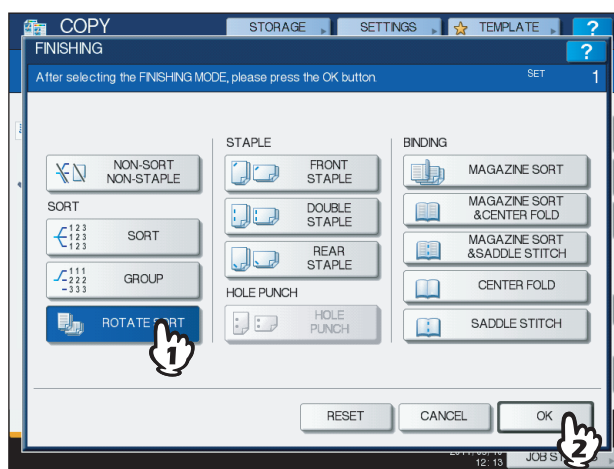

5 Key in the desired number of copies.

- 6** Select other copy modes as required, and then press the [START] button on the control panel.

■ Staple sort mode

When you make more than one set of copies, the copied paper can be automatically stapled set by set. This mode is called the staple sort mode. You can choose from 3 different stapling positions.

Example: When [FRONT STAPLE] is selected

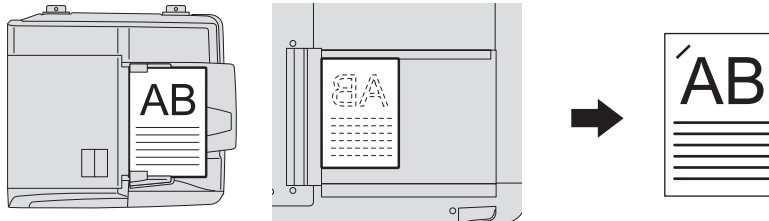

Notes

- Special paper such as OHP film or sticker labels is not applicable.
- Copies in different sizes cannot be stapled. (If the lengths of the copies are the same, they can be stapled.)

- 1 Place paper in the drawer(s).**
When using bypass copying, be sure to set the paper size.
- 2 Place the original(s).**
- 3 Press [FINISHING] on the touch panel.**
- 4 Select the desired stapling position from [FRONT STAPLE], [DOUBLE STAPLE] or [REAR STAPLE], and then press [OK].**

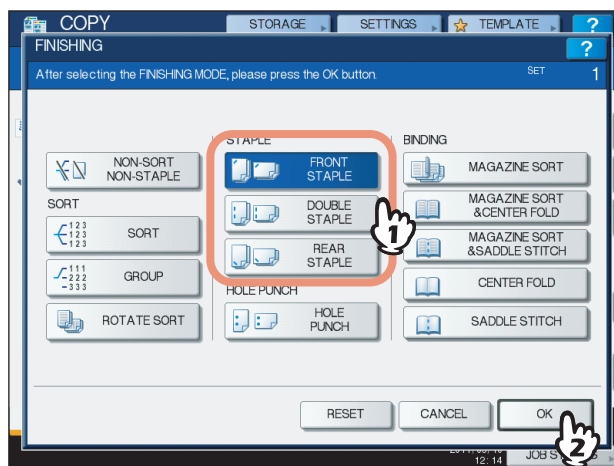

- 5** Select other copy modes as required, and then press the [START] button on the control panel.

Tip

When the number of sheets exceeds the maximum number of sheets available for stapling, this equipment automatically enters into the sort mode.

□ Maximum number of sheets available for stapling

The maximum number of sheets available for stapling differs depending on the paper size and weight.

Paper size	Paper weight		
	64 - 80 g/m ² (17 - 20 lb. Bond)	81 - 90 g/m ² (21 - 24 lb. Bond)	91 - 105 g/m ² (25 - 28 lb. Bond)
A4, B5, LT	50 sheets	50 sheets	30 sheets
A3, A4-R, B4, FOLIO, LD, LG, LT-R, COMP	30 sheets	30 sheets	15 sheets

Notes

- 2 cover sheets can be added to paper whose weight is 64 to 256 g/m² (17 lb. Bond to 140 lb. Index). In this case, the number of sheets available includes the 2 cover sheets.
- For the maximum number of sheets loadable on the tray, refer to the **Quick Start Guide**.

■ Magazine sort / Center fold / Saddle stitch

You can copy more than one original and bind them in a booklet format (Magazine sort). With the Saddle Stitch Finisher, you can also have the copied booklet folded at its center (Center fold) and stapled (Saddle stitch).

Magazine sort mode

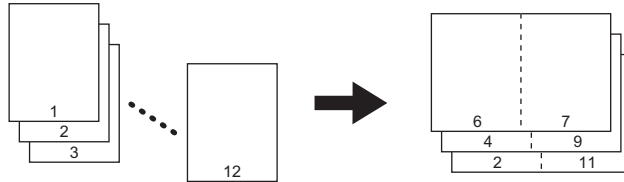

Center fold mode

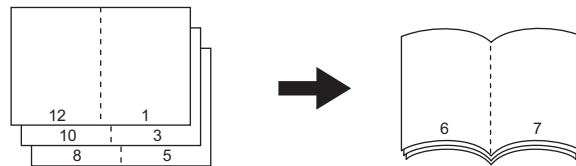

Saddle stitch mode

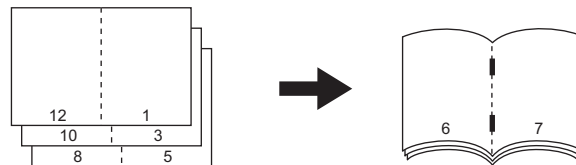

Magazine sort & center fold mode

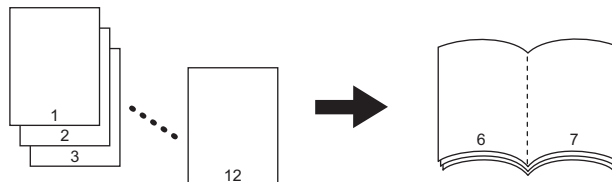

Magazine sort & saddle stitch mode

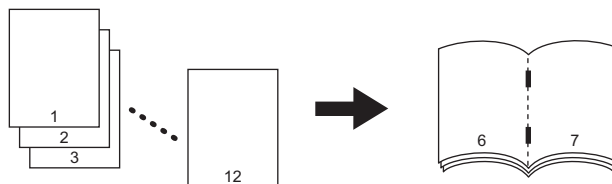

Requirements for center folding

Paper size	Paper weight	Maximum number of sheets available for center folding *1	Maximum number of sets loadable on the saddle stitch tray
A3, A4-R, B4, LD, LT-R, LG	64 - 105 g/m ² (17 - 28 lb. Bond)	25 sheets	21 - 25 sheets/set: 5 sets 16 - 20 sheets/set: 6 sets 11 - 15 sheets/set: 8 sets 6 - 10 sheets/set: 12 sets Less than 5 sheets/set: 25 sets

*1 1 cover sheet (64 to 256 g/m² (17 lb. Bond to 140 lb. Index)) can be added. In this case the number of sheets per set shall include the cover sheet.

Requirements for saddle stitching

Paper size	Paper weight *1	Maximum number of sheets available for saddle stitching *2	Maximum number of sets loadable on the saddle stitch tray
A3, A4-R, B4, LD, LT-R, LG	64 - 90 g/m ² (17 - 24 lb. Bond)	15 sheets	11 - 15 sheets: 25 sets (10 sets if cover sheets are added) 6 - 10 sheets: 30 sets (15 sets if cover sheets are added) Less than 5 sheets: 50 sets
	91 - 105 g/m ² (25 - 28 lb. Bond)	10 sheets	6 - 10 sheets: 25 sets (15 sets if cover sheets are added) Less than 5 sheets: 40 sets (30 sets if cover sheets are added)

*1 When the paper weights are mixed, take the value of the heavier one.

*2 1 cover sheet (64 to 256 g/m² (17 lb. Bond to 140 lb. Index)) can be added. In this case the number of sheets per set shall include the cover sheet.

Tip

When placing portrait originals in a landscape direction as shown on the right in the magazine sort mode, magazine sort & center fold mode or the magazine sort & saddle stitch mode, set the image direction function to ON on the EDIT menu.

📖 P.118 "Image Direction"

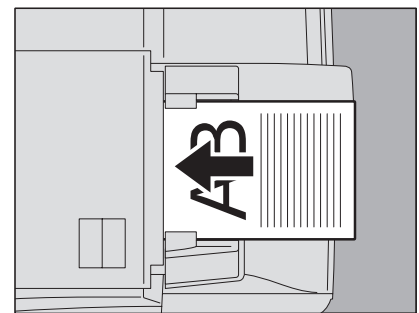

The magazine sort mode can also be selected on the EDIT menu. If you select it on the EDIT menu, you can adjust the binding margin. For details, see the following page:

📖 P.100 "Magazine Sort Mode"

1 Place paper in the drawer(s).

Note

Special paper such as OHP film or sticker labels is not applicable.

2 Select the desired paper size.

A3, A4-R, A5-R *1, B4 or B5-R *1 size paper can be used.

*1 A5-R and B5-R are acceptable only for the magazine sort mode.

3 Place the original(s).

When placing the originals on the RADF, place them according to the illustration on the previous page.

When placing the originals on the original glass, place them in the following order:

Magazine sort, Magazine sort & center fold, Magazine sort & saddle stitch: Place the first page of the original first.

Center fold, Saddle stitch: For example, if the total number of pages is 12, place pages 1 and 12 together, and then pages 2 and 11, 10 and 3, 4 and 9, 8 and 5, and finally pages 6 and 7.

4 Press [FINISHING] on the touch panel.

- 5** Select the desired mode from [MAGAZINE SORT], [MAGAZINE SORT & CENTER FOLD], [MAGAZINE SORT & SADDLE STITCH], [CENTER FOLD] or [SADDLE STITCH]. Then press [OK].

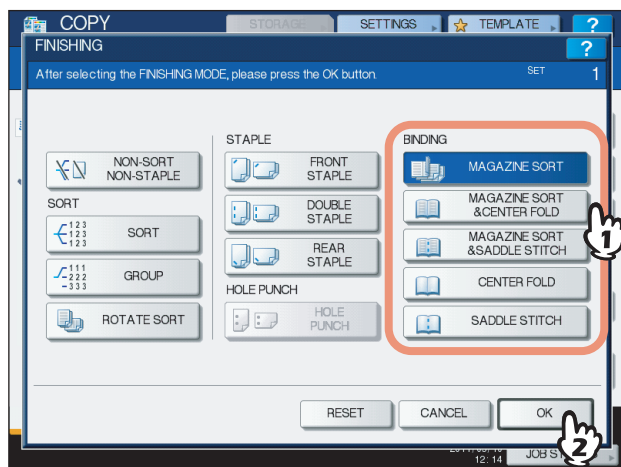

Note

Modes other than [MAGAZINE SORT] are selectable only when the Saddle Stitch Finisher (optional) is installed.

- 6** Select other copy modes as required, and then press the [START] button on the control panel.

- 7** Combine the copied paper if the center fold mode or magazine sort & center fold mode is used.

In the center fold mode, paper is folded at the center for every 5 sheets before exiting. If more than 5 sheets of paper are copied, combine them as shown in the figure.

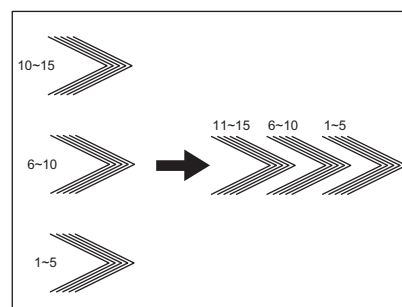

■ Hole punch mode

You can punch copied paper when the Hole Punch Unit (optional) is installed on the Finisher.

Notes

- Paper whose size is any of A3, A4, A4-R, B4, B5, B5-R, FOLIO, LD, LG, LT, LT-R, ST-R and COMP, and whose weight is 64 to 256 g/m² (17 lb. Bond to 140 lb. Index) is available.
- Special paper such as OHP film or sticker labels is not applicable.

- 1 Place paper in the drawer(s).**
When using bypass copying, be sure to set the paper size.
- 2 Place the original(s).**
- 3 Press [FINISHING] on the touch panel.**
- 4 Select [HOLE PUNCH], and then press [OK].**

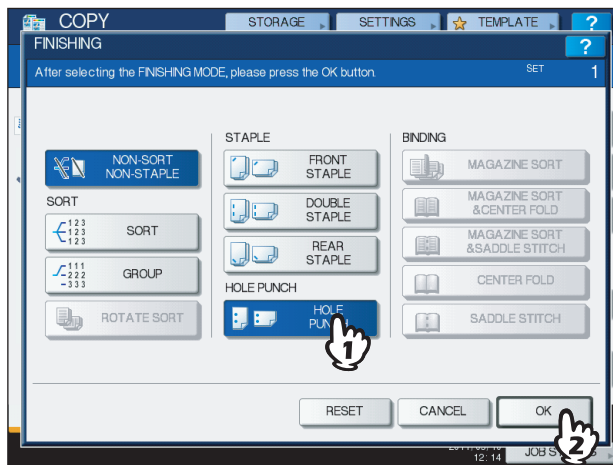

- 5 Select other copy modes as required, and then press the [START] button on the control panel.**

Manual staple mode

You can staple copied paper manually without any copying operation. This is useful when you have forgotten to set the staple sort mode before starting copying, or when you want to staple originals.

Maximum number of sheets available for manual stapling

Paper size	Paper weight		
	64 - 80 g/m ² (17 - 20 lb. Bond)	81 - 90 g/m ² (21 - 24 lb. Bond)	91 - 105 g/m ² (25 - 28 lb. Bond)
A4, B5, LT	50 sheets	50 sheets	30 sheets
A3, A4-R, B4, FOLIO, LD, LG, LT-R, COMP	30 sheets	30 sheets	15 sheets

Use the buttons on the stapling control section of the Finisher (optional) for manual stapling.

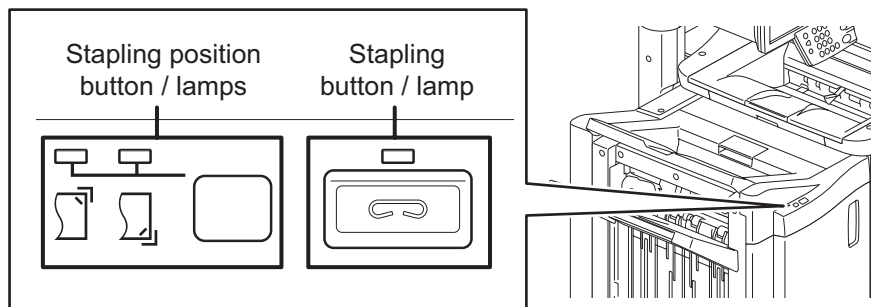

1 Press the stapling button on the stapling control section.

The shutter of the paper exit area is opened and this equipment enters into the manual staple mode.

2 Press the stapling position switching button to switch the staple position (front or rear).

3 Place paper on the lower receiving tray of the Finisher (optional).

Fan and jog the paper well. Place it with its face down. When you staple them at their corner on the front side, place the sheets of paper aligned to the front side. When you staple them on the rear side, place the sheets of paper aligned to the rear side.

Tip

The stapling lamp lights when the paper is properly placed. If it does not light, replace the paper.

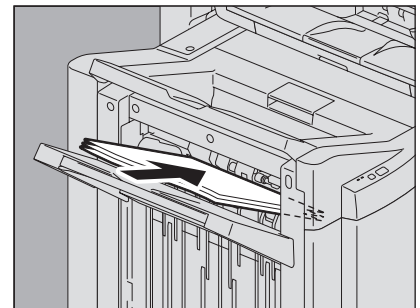

4 Let go of the paper, and then press the stapling button.

Stapling starts. When the stapling position switching lamps start blinking, it means the stapling has finished. Then remove the stapled paper.

⚠ CAUTION

Be sure that your hands are away from the paper while stapling is in progress.

Finishing the manual staple mode

Remove the stapled paper from the lower receiving tray, and then press the stapling button. The shutter of the paper exit area closes. This means that manual stapling is finished. If no operation is performed for approx. 15 seconds, the manual staple mode will be automatically finished.

Duplex Copying

You can copy a 1-sided original to a 2-sided copy or vice versa, or copy a 2-sided original to a 2-sided copy. This is useful when you want to save the paper, or when you want to copy a book-type original maintaining the same page order.

1-sided original -> 1-sided copy (📖 P.78)

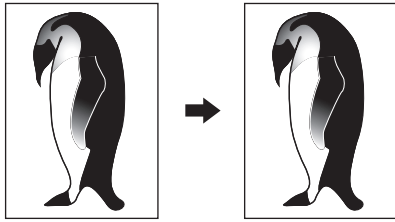

2-sided original -> 1-sided copy (📖 P.78)

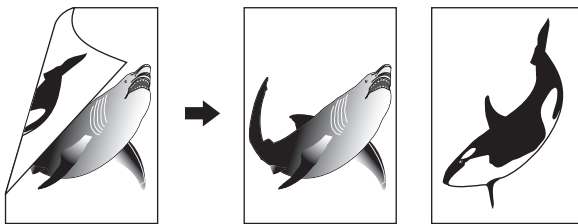

1-sided original -> 2-sided copy (📖 P.79)

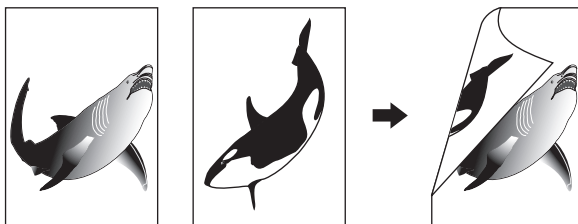

2-sided original -> 2-sided copy (📖 P.79)

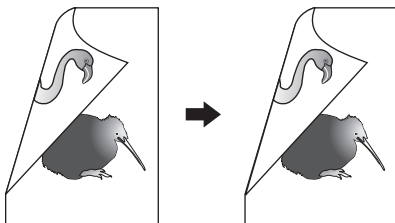

Book-type original -> 2-sided copy (📖 P.80)

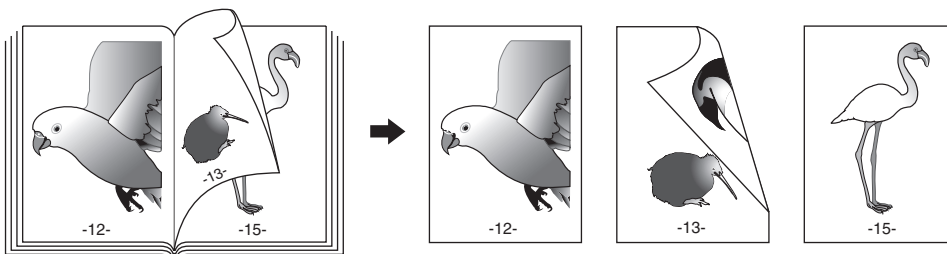

Note

Use plain paper, recycled paper, THICK 1, THICK 2, THICK 3, special paper 1 or special paper 2 for duplex copying.

■ Making a 1-sided copy

Tip

When you copy 2-sided portrait originals which open to the left/right on only 1 side of the paper, use the image direction function on the EDIT menu so that all the copied paper will exit in the proper direction.

📖 P.118 "Image Direction"

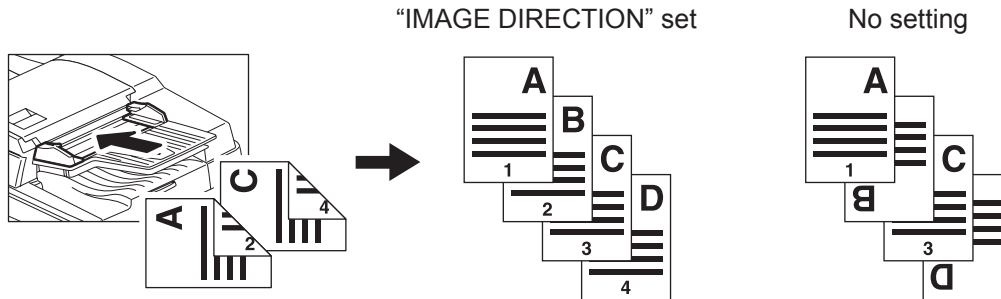

- 1 Place paper in the drawer(s).**
When using bypass copying, be sure to set the paper size.
- 2 Place the original(s).**
- 3 Press [2-SIDED] on the touch panel.**
- 4 Select the desired mode, and then press [OK].**
 [1->1 SIMPLEX]: 1-sided original to 1-sided copy
 [2->1 SPLIT]: 2-sided original to 1-sided copy

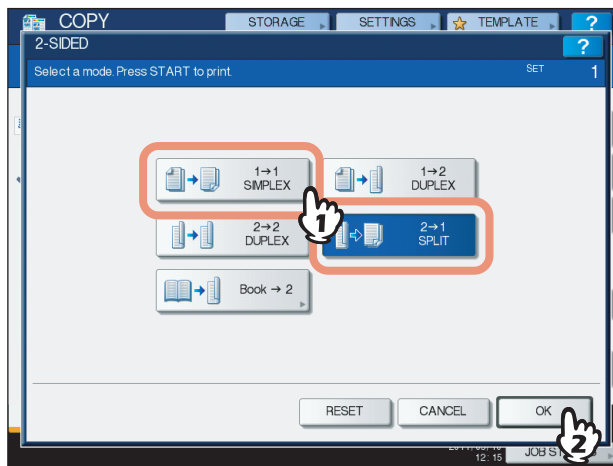

- 5 Select other copy modes as required, and then press the [START] button on the control panel.**

■ Making a 2-sided copy

Tip

If 1-sided portrait originals have been placed in a landscape direction and you copy them on both sides of the paper, copied sheets are usually in the open to top/bottom direction. You can make copies in the open to left/right direction with the image direction function.

📖 P.118 “Image Direction”

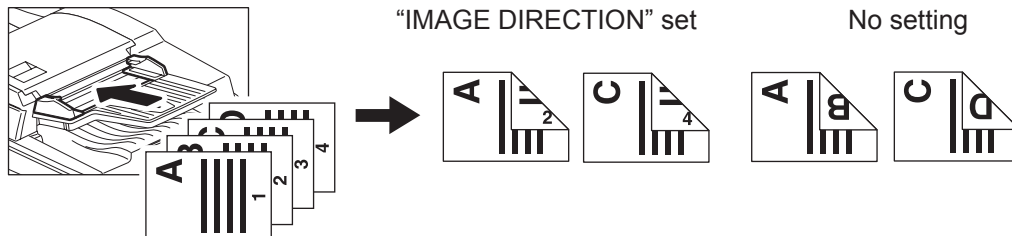

- 1 Place paper in the drawer(s).**
When using bypass copying, be sure to set the paper size.
- 2 Place the original(s).**
- 3 Press [2-SIDED] on the touch panel.**
- 4 Select the desired mode, and then press [OK].**
[1 → 2 DUPLEX]: 1-sided original to 2-sided copy
[2 → 2 DUPLEX]: 2-sided original to 2-sided copy

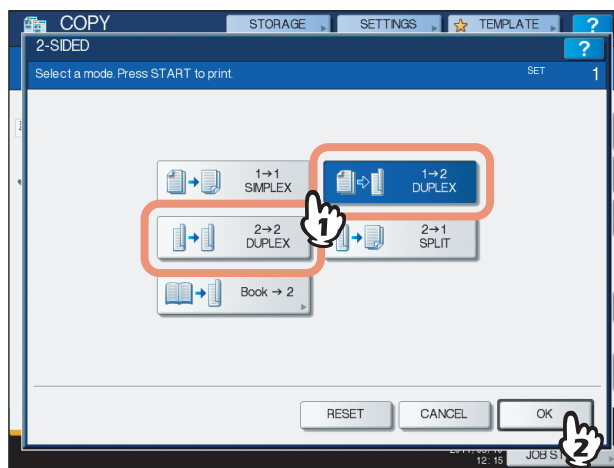

- 5 Select other copy modes as required, and then press the [START] button on the control panel.**

When placing the original on the original glass, follow steps 6 and 7 on 📖 P.30 “Basic copying procedure”.

■ Making a 2-sided copy from a book-type original

You can make 2-sided copies from book-type originals such as books or catalog as in the same page order.

Tip

A4, B5 and LT sizes are applicable.

- 1 Place paper in the drawer(s).**
When using bypass copying, be sure to set the paper size.
- 2 Press [2-SIDED] on the touch panel.**
- 3 Select [Book -> 2].**

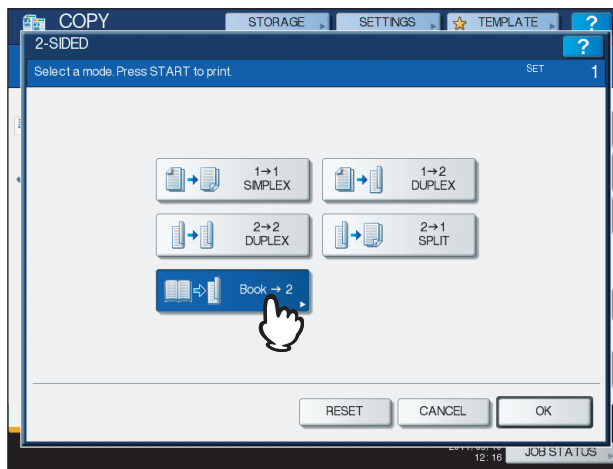

- 4 Select the book copying type.**

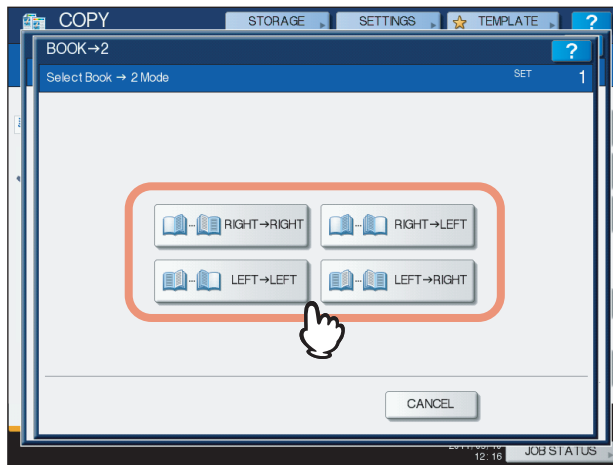

Example: If pages 2 to 6 of a book which opens to the left are to be copied, select [LEFT -> LEFT].

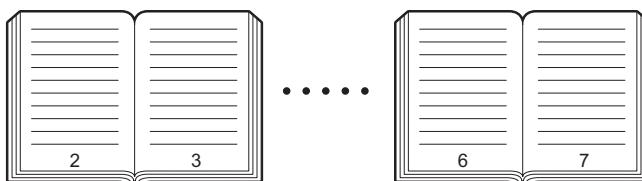

5 Press [OK].

The menu returns to the BASIC menu.

6 Press the drawer button corresponding to the desired paper size.

Only A4, B5 and LT sizes are applicable.

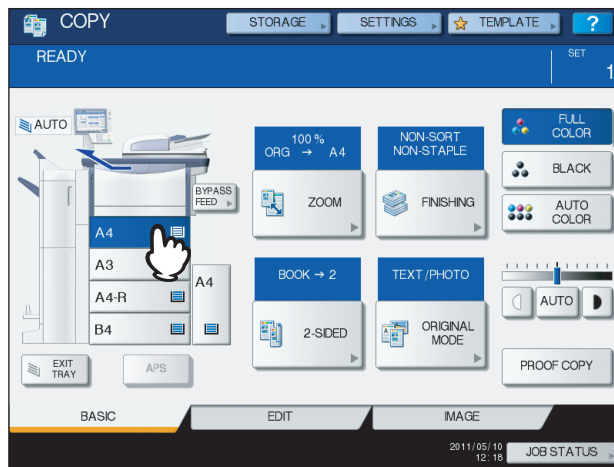
**7 Select other copy modes as required.**

If the copy needs a binding space, select the book margin mode on the EDIT menu.

P.90 "Creating bookbinding margin"

8 Place the original on the original glass.

Place the original with its bottom toward you, aligning its center with the yellow indicator under the original glass.

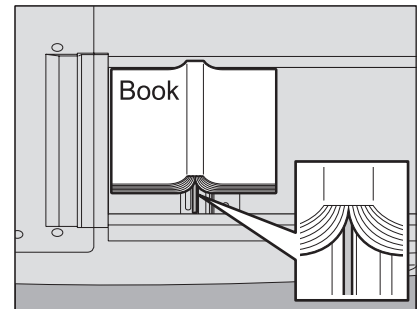
**⚠ CAUTION**

Do not place any heavy objects (4 kg (9 lb.) or over) on the original glass and do not press on it with force.

Breaking the glass could injure you.

9 Press the [START] button on the control panel. Once the pages are scanned, set the next ones on the original glass.

Repeat this step until all the desired pages have been scanned. If the last page is a single page, press [COPY FINAL PAGE] on the touch panel, and then press the [START] button on the control panel to start scanning. The scanned pages will be copied.

10 When all the pages have been scanned, press [FINISHED].

The scanned pages will be copied.

Performing Copy & File

With the Copy & File function, you can store the copied data in the share folder of the hard disk of this equipment or a specified PC on a network. The data can be stored in any of PDF, TIFF and XPS formats.

Notes

- The data will be stored as black images. (Resolution: 600 dpi only) The data stored with this function are suited for printing but not for being imported as an image into your PC. To obtain the optimal image quality for importing, it is recommended to store the data with the Scan to File function of this equipment.
- The network administrator must make settings for Copy & File in advance. For details, refer to the **TopAccess Guide**.
- It is recommended to back up the data stored in the share folder.

Tip

You can store data in an e-Filing box with the Store to e-Filing function. For details, refer to the **e-Filing Guide**.

1 Place the original(s).

2 Press [STORAGE] on the touch panel.



3 Press [COPY & FILE] on the touch panel.

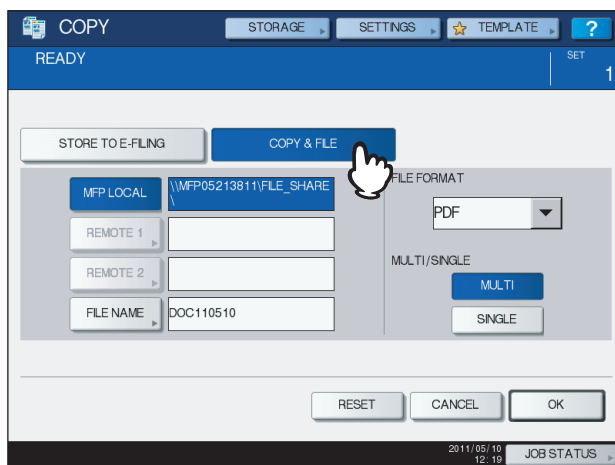

4 Press the necessary buttons for entering information about the data to be stored. Then press [OK].

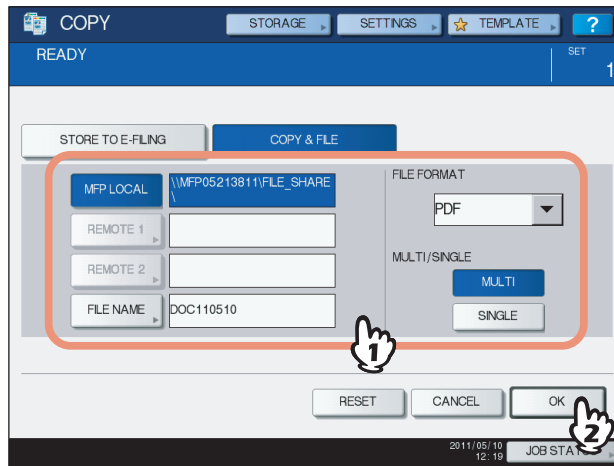

MFP LOCAL: Press this to store the data into the share folder of this equipment.

REMOTE 1, REMOTE 2: Press either of them to store the data into the share folder of a PC that is connected with this equipment via a network.

Notes

- You can select up to 2 of [MFP LOCAL], [REMOTE 1] and [REMOTE 2]. You can cancel the selected item by pressing the same button again.
- When a user who has the privilege of changing the setting of [REMOTE 1] and [REMOTE 2] has pressed either of them, the menu for specifying a directory appears. In this case, see the following page to specify the directory:
 P.84 "Setting share folder"

FILE NAME: Press this to display the on-screen keyboard. Then enter the file name within 128 letters.

Note

The trailing characters in a file name (maximum 74) may be deleted depending on the type of letters used.

FILE FORMAT: Select the file format in which the data are stored from PDF, TIFF or XPS.

MULTI / SINGLE: These are for selecting whether the data are stored as a multiple page file or a single page file. If you select "MULTI", all the scanned data will be stored as one file. If you select "SINGLE", a folder is created and each page of the scanned data will be stored individually as one file in the folder.

5 Press the [START] button on the control panel.

When the original is placed on the RADF (Reversing Automatic Document Feeder), copying and storing start simultaneously.

When the original is placed on the original glass, follow the procedure below.

6 Place the next original on the original glass, and then press [NEXT COPY] on the touch panel or the [START] button on the control panel.

Repeat this step until the scanning of all the originals is finished.

7 When all have been scanned, press [JOB FINISH] on the touch panel.

Copying and storing start.

■ Setting share folder

When a user who has the privilege of setting a share folder has pressed [REMOTE 1] or [REMOTE 2], the menu for specifying a directory appears.

The setting items differ depending on the file transfer protocol to be used. FTP, SMB, NetWare IPX/SPX, NetWare TCP/IP and FTPS are selectable for a file transfer protocol.

FTP / FTPS

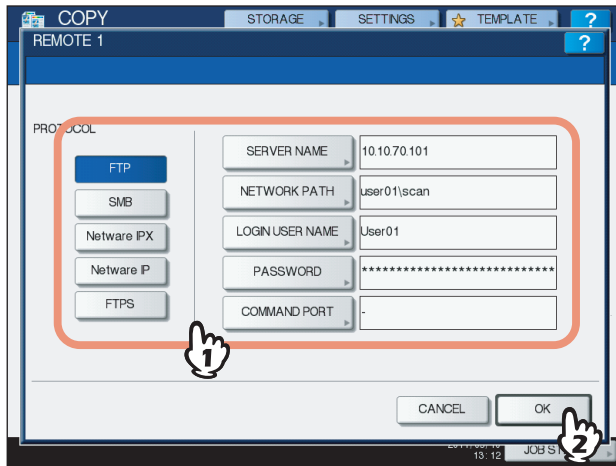

When you press any of the buttons below, the on-screen keyboard appears. Enter with the buttons on the touch panel or the digital keys on the control panel. When you finish the entry, press [OK].

SERVER NAME: Press this to enter the IP address of FTP server. For example, if the data should be transferred to an FTP folder ftp://10.10.70.101/user01/scan/, key in "10.10.70.101".

NETWORK PATH: Press this to enter a network path to an FTP folder where the data are to be stored. For example, if the data should be transferred to an FTP folder ftp://10.10.70.101/user01/scan/, enter "user01\scan".

LOGIN USER NAME: Press this to enter a user name to login to the FTP server. Enter this as required.

PASSWORD: Press this to enter a password to login to the FTP server. Enter this as required.

COMMAND PORT: Press this to key in a command port number for executing commands. Normally "-" is entered in this field, which means that a port number set by the administrator will be used. Change this only when you want to use any other port number.

SMB

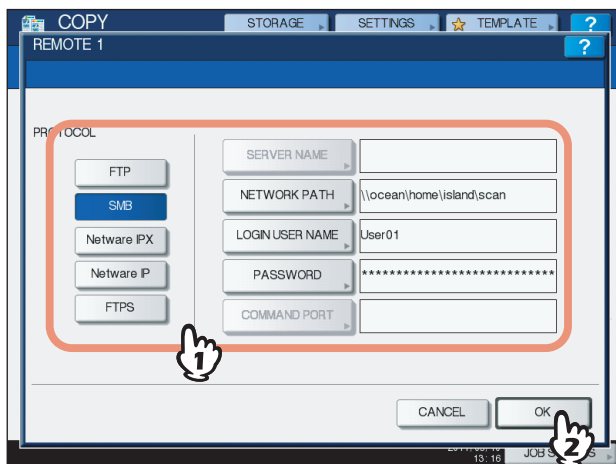

When you press any of the buttons below, the on-screen keyboard appears. Enter with the buttons on the touch panel or the digital keys on the control panel. When you finish the entry, press [OK].

NETWORK PATH: Press this to enter a network path to the folder where the data are to be stored.

LOGIN USER NAME: Press this to enter a user name to access the network folder. Enter this as required.

PASSWORD: Press this to enter a password to access the network folder. Enter this as required.

Tip

If you selected [SMB], the settings for [SERVER NAME] and [COMMAND PORT] are not required.

NetWare IPX / NetWare IP

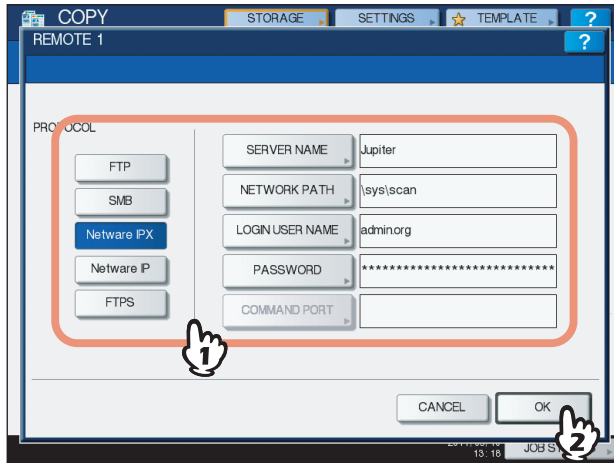

When you press any of the buttons below, the on-screen keyboard appears. Enter with the buttons on the touch panel or the digital keys on the control panel. When you finish the entry, press [OK].

SERVER NAME: When you select [NetWare IPX], enter either the server name of NetWare server or Tree/Context (if NDS is useable). When you select [NetWare IP], enter the IP address of NetWare server.

NETWORK PATH: Press this to enter a network path to a NetWare server folder where the data are to be stored. For example, if the data should be transferred to a folder “sys\scan” of NetWare server, enter “\\sys\scan”.

LOGIN USER NAME: Press this to enter a user name to login NetWare server. Enter this as required.

PASSWORD: Press this to enter a password to login NetWare server. Enter this as required.

4

EDITING FUNCTIONS

This chapter describes how to use various copying functions on the EDIT menu.

Displaying EDIT Menu	88
Image Shift	89
Creating top/bottom margin or left/right margin	89
Creating bookbinding margin	90
Edge Erase	92
Book Center Erase	93
Dual Page	95
2IN1 / 4IN1	97
Magazine Sort Mode	100
Image Editing	102
Trimming / Masking	102
Mirror image / Negative/positive reversal	105
XY Zoom	106
Cover Sheet	107
Sheet Insertion	109
Time Stamp	112
Page Number	113
Job Build	115
Image Direction	118
Book - Tablet	119
ADF -> SADF	120
Full Image	121
Image Repeat	122
Omit Blank Page	124
Outside Erase	125

Displaying EDIT Menu

You can display the EDIT menu by pressing the [EDIT] tab on the touch panel when you want to use various editing functions.

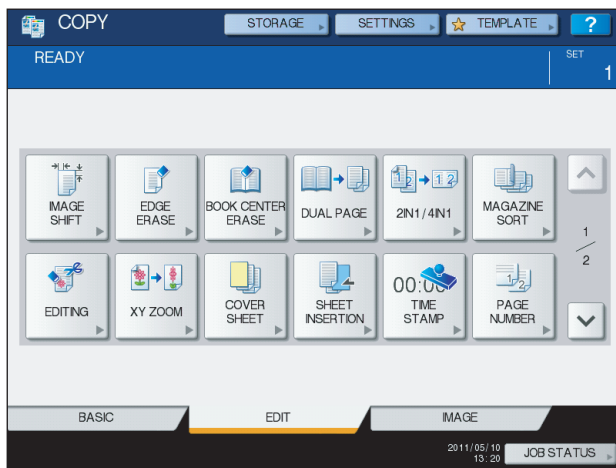



The EDIT menu has 2 pages. To switch the pages, press  or .



Image Shift

You can create a binding margin by shifting an image to the left, right, top or bottom of the copy paper. This function is called "image shift". It is useful when you wish to punch or staple a stack of paper after copying it. With this function you can easily make a binding margin when you copy a book-type original on both sides of the paper.

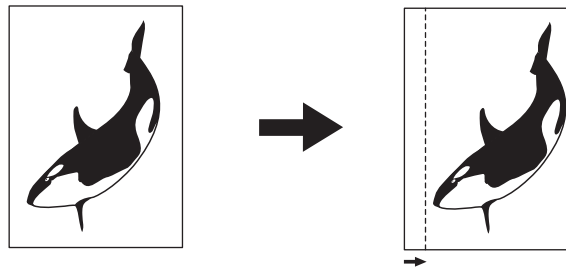

Tip

You can make a binding margin in the combinations as follows:

- Top/bottom margin and left/right margin
- Top/bottom margin and bookbinding margin

■ Creating top/bottom margin or left/right margin

- 1 Place paper in the drawer(s).**
When using bypass copying, be sure to set the paper size.
- 2 Place the original(s).**
- 3 Press [IMAGE SHIFT] on the EDIT menu.**
- 4 Select the type of binding margin.**

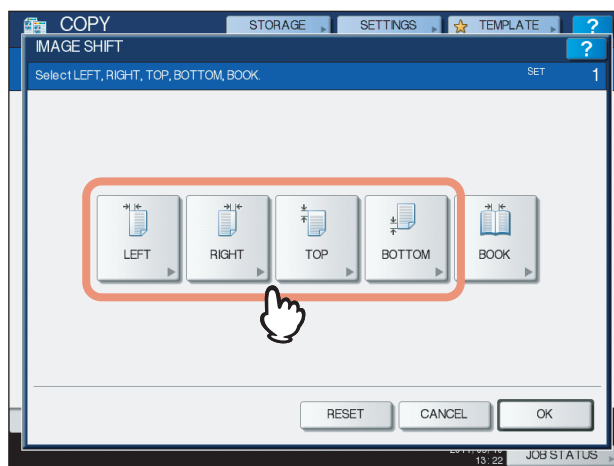

5 Adjust the width of the binding margin.

- 1) Press [FRONT MARGIN] and adjust the binding margin width on the front side using [▼ 0 mm] (0") and [▲ 100 mm] (3.94"). (The width on the back side will be also adjusted in the same way.)
- 2) Press [BACK MARGIN] and adjust the binding margin width on the back side using [▼ 0 mm] (0") and [▲ 100 mm] (3.94"). (Only the width on the back side will be adjusted.)
- 3) Press [OK].

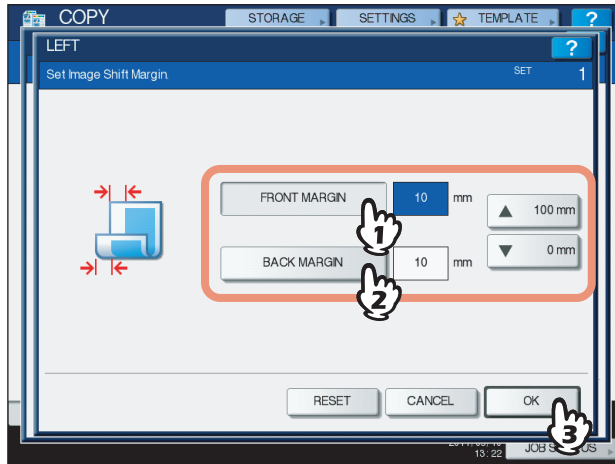

Tip

Note that a left/right binding margin will be created on the opposite side on the back side of paper in duplex copying. (For example, when a binding margin is created on the right of the front side of the paper, it will be created on the left of the back side.)

6 Press [OK].

7 Select other copy modes as required, and then press the [START] button on the control panel.

■ Creating bookbinding margin

You can easily make a binding margin when you copy a book-type original on both sides of the paper.

📖 P.80 "Making a 2-sided copy from a book-type original"

1 Press [IMAGE SHIFT] on the EDIT menu.

2 Press [BOOK].

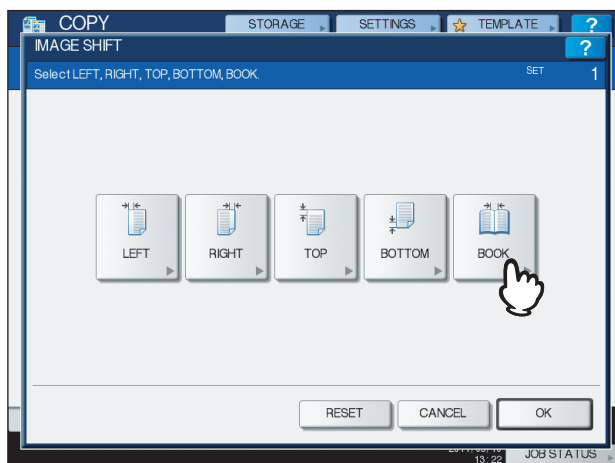

3 Adjust the width of the binding margin.

- 1) Press either [▼ 0 mm] (0") or [▲ 30 mm] (1.18").
- 2) Press [OK].

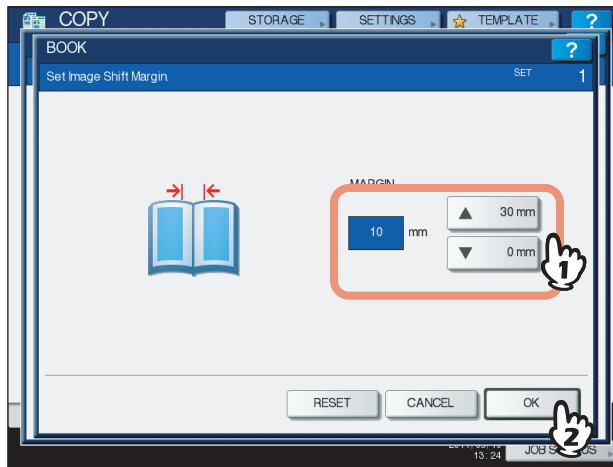

4

4 Press [OK].

Select the "Book-type original -> 2-sided copy" mode as well.

📖 P.80 "Making a 2-sided copy from a book-type original"

Edge Erase

You can whiten the edge of the copied image when a shadow-like dark part appears on it. This function is called "edge erase". It is useful when you want to make the copied image neat and clear if the edge of the original is dirty or torn.

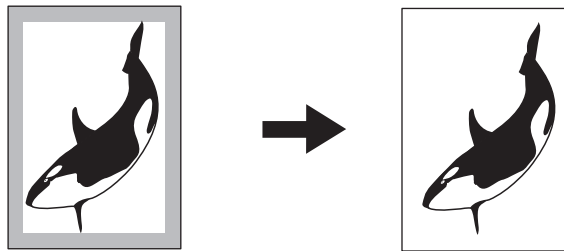

Tip

Only standard size originals are applicable.

- 1 Place paper in the drawer(s).**
When using bypass copying, be sure to set the paper size.
- 2 Place the original(s).**
- 3 Press [EDGE ERASE] on the EDIT menu.**
- 4 Adjust the width of the part to be erased.**
 - 1) Press either [▼ 2 mm] (0.08") or [▲ 50 mm] (1.97").
 - 2) Press [OK].

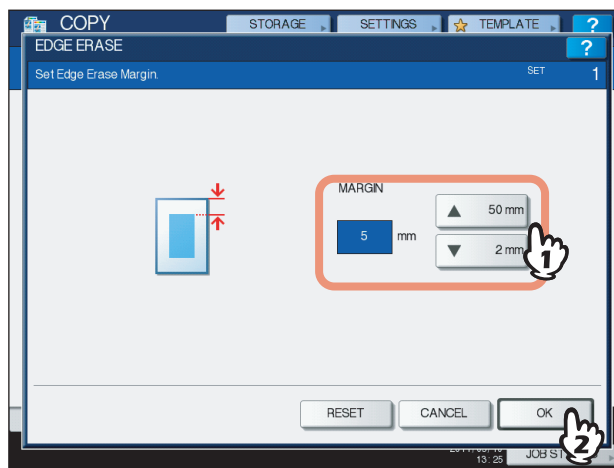

- 5 Select other copy modes as required, and then press the [START] button on the control panel.**

Book Center Erase

You can whiten the center of the copied image when a shadow-like part appears on it. This function is called “book center erase”. It is useful when you copy book-type originals.

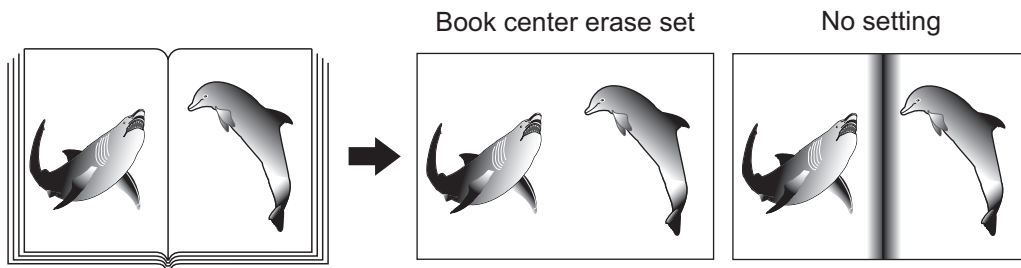

4

- 1 Place paper in the drawer(s).**
When using bypass copying, be sure to set the paper size.
- 2 Select the drawer for the desired paper size.**



- 3 Press [BOOK CENTER ERASE] on the EDIT menu.**

4 Adjust the width of the part to be erased.

- 1) Press either [∇ 2 mm] (0.08") or [\blacktriangle 50 mm] (1.97").
- 2) Press [OK].

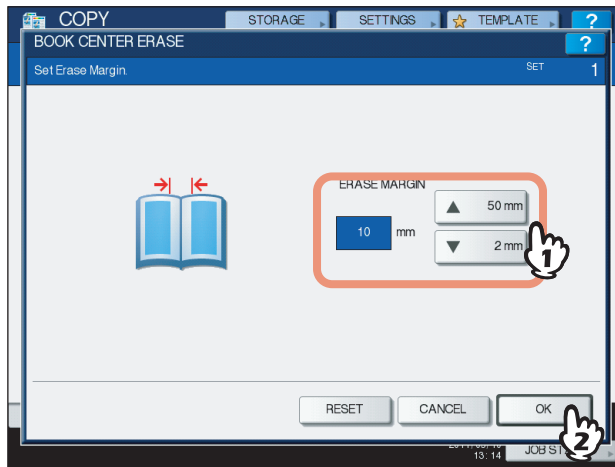

5 Place the original on the original glass.

Place the original with its bottom toward you, aligning its center with the yellow indicator under the original glass.

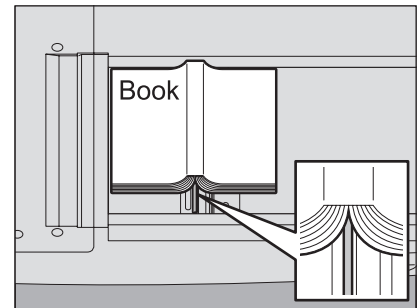

⚠ CAUTION

Do not place any heavy objects (4 kg (9 lb.) or over) on the original glass and do not press on it with force.

Breaking the glass could injure you.

6 Select other copy modes as required, and then press the [START] button on the control panel.

Dual Page

You can copy the 2 facing pages of a book-type original or 2 original sheets placed side by side onto 2 separate sheets of paper or on both sides of 1 sheet of paper. This function is called “dual page”. You do not have to shift the original on the original glass.

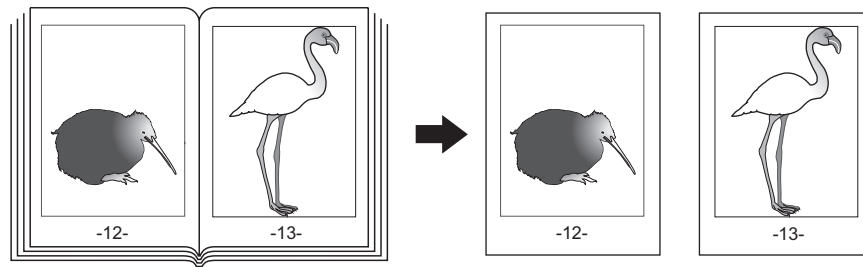

Tip

Only A4, B5 and LT sizes are applicable.

1 Place paper in the drawer(s).

2 Press [DUAL PAGE] on the EDIT menu.

3 Press [1 SIDE] or [2 SIDE].

- 1 SIDE: Copying the 2 facing pages of the original to only 1 side of 2 separate sheets of paper
- 2 SIDE: Copying the 2 facing pages of the original to 2 sides of 1 sheet of paper

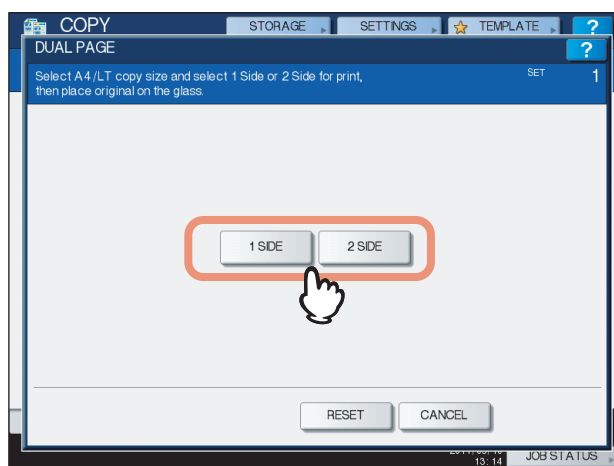

4 Select other copy modes as required.

You can select “image shift” as well.

P.89 “Creating top/bottom margin or left/right margin”

5 Press the [BASIC] tab to display the BASIC menu, and then select A4, B5 or LT as the copy paper size.

When using bypass copying, be sure to set the paper size.

6 Open the desired page of the original and place it on the original glass.

Place the original with its bottom toward you, aligning its center with the yellow indicator under the original glass.

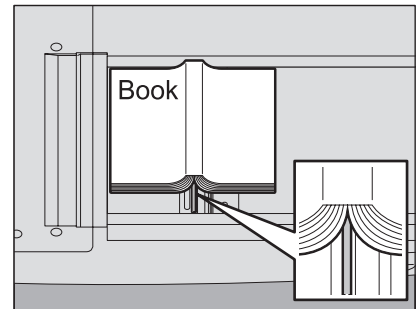

⚠ CAUTION

Do not place any heavy objects (4 kg (9 lb.) or over) on the original glass and do not press on it with force.

Breaking the glass could injure you.

7 Press the [START] button on the control panel. When the scanning of the opened pages is finished, open the next pages and place them.

Repeat this procedure until all the desired pages have been scanned. If the last page is a single page, press [COPY FINAL PAGE] on the touch panel, and then press the [START] button on the control panel to start scanning. The scanned pages will be copied.

8 When all the pages have been scanned, press [FINISHED].

The scanned pages will be copied.

2IN1 / 4IN1

You can copy 2 or 4 originals to 1 sheet of paper by shrinking them. This function is called “2IN1” or “4IN1”. If you use this function together with duplex copying, you can make a total of 8 images on 1 sheet of paper.

The illustrations below show how you can arrange the images.

2IN1

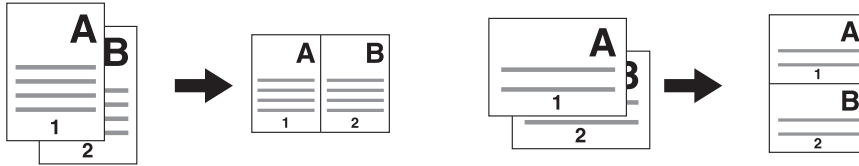

4IN1

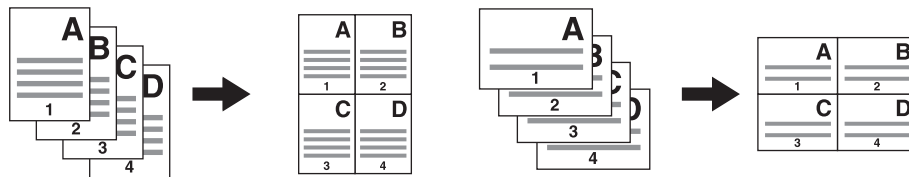

2IN1 & duplex copying (a: side 1, b: side 2)

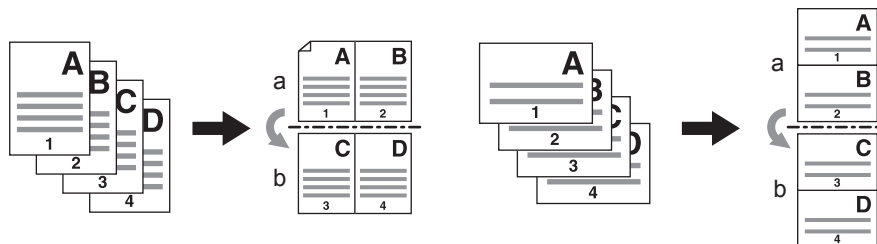

4IN1 & duplex copying (a: side 1, b: side 2)

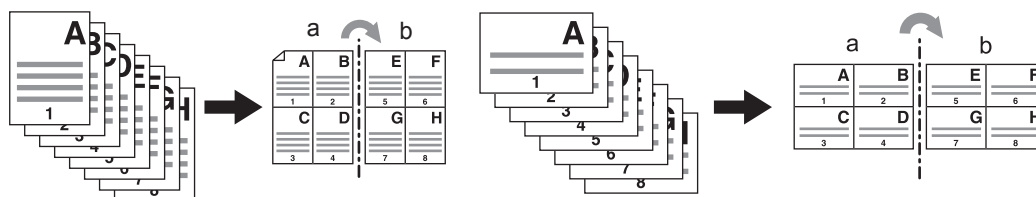

1 Place paper in the drawer(s).

When using bypass copying, be sure to set the paper size.

Tip

If you select paper of a different size to that of the original, press [ZOOM] on the BASIC menu. Next select the desired paper size, press [AMS] and then [OK] in the menu shown below.

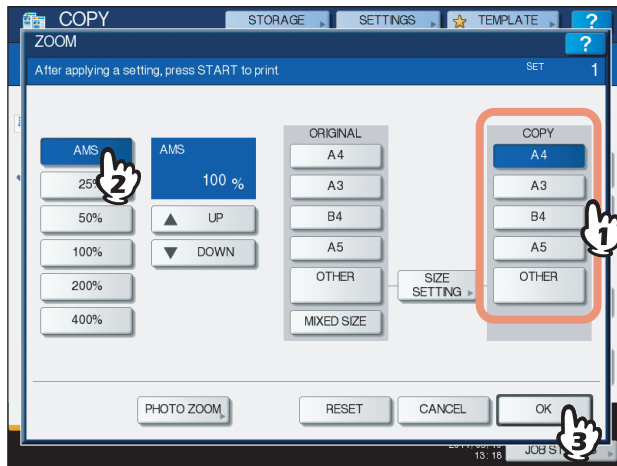

2 Place the original(s).

3 Press [2IN1 / 4IN1] on the EDIT menu.

4 Perform 2IN1 / 4IN1 setting.

- 1) If you want to copy 2 originals on 1 page, select [2IN1]. If you want 4 on 1 page, select [4IN1].
- 2) Select the duplex mode.
- 3) Press [OK].

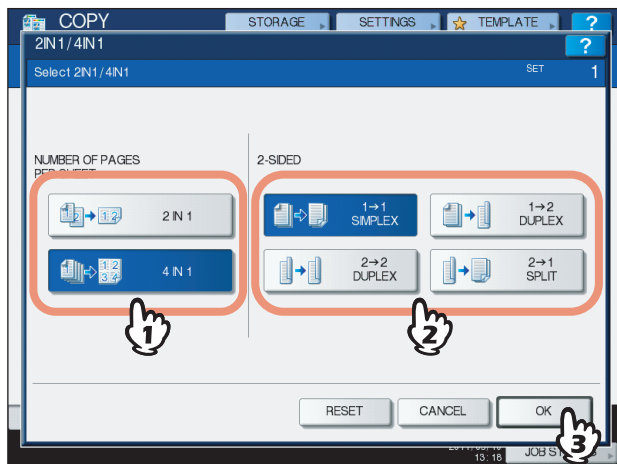

5 Select other copy modes as required, and then press the [START] button on the control panel.

When the originals are placed on the RADF, scanning and copying start. When they are placed on the original glass, follow steps 6 and 7.

6 Place the next original, and then press [NEXT COPY] on the touch panel or the [START] button on the control panel.

Scanning of the next original starts. If you have more than one original, repeat this step until the scanning of all the originals is finished.

-
- 7** When the scanning of all the originals is finished, press [JOB FINISH] on the touch panel.
Copying starts.

Magazine Sort Mode

You can copy more than one original in the book-type page order. This mode is called the magazine sort mode. Also you can do this as well as fold and staple the copied sheets at their center. This mode is called the magazine sort & saddle stitch mode.

Magazine sort mode

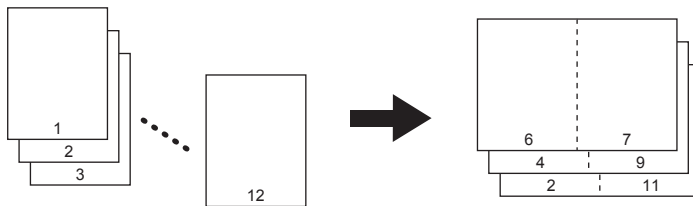

Magazine sort & saddle stitch mode

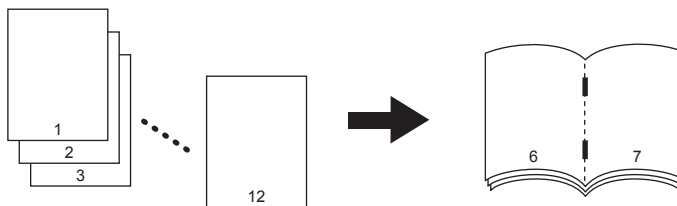

The magazine sort mode can also be selected on the BASIC menu. For details, see the following page:
 📖 P.72 “Magazine sort / Center fold / Saddle stitch”

1 Place paper in the drawer(s).

Sizes are available as follows:

Magazine sort & saddle stitch: A3, A4-R, B4, LD, LG, LT-R

2 Select the paper size.

Drawer: 📖 P.50 “Automatic Paper Selection (APS)”

Bypass tray: 📖 P.37 “Bypass Copying”

3 Place the original(s).

Tip

When placing portrait originals in a landscape direction as shown on the right in the magazine sort mode or the magazine sort & saddle stitch mode, set the image direction function to ON on the EDIT menu. Otherwise the originals will not be copied in the proper page order.

📖 P.118 “Image Direction”

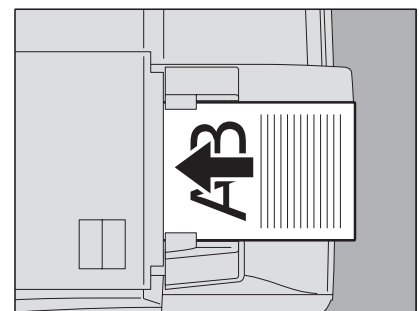

4 Press [MAGAZINE SORT] on the EDIT menu.

5 Set the saddle stitch mode and the binding margin width as required.

- 1) When setting the saddle stitch mode, press [STAPLE ON]. If not required, press [STAPLE OFF].
- 2) Press either [▼ 2 mm] (0.08") or [▲ 30 mm] (1.18") to adjust the binding margin width.
- 3) Press [OK].

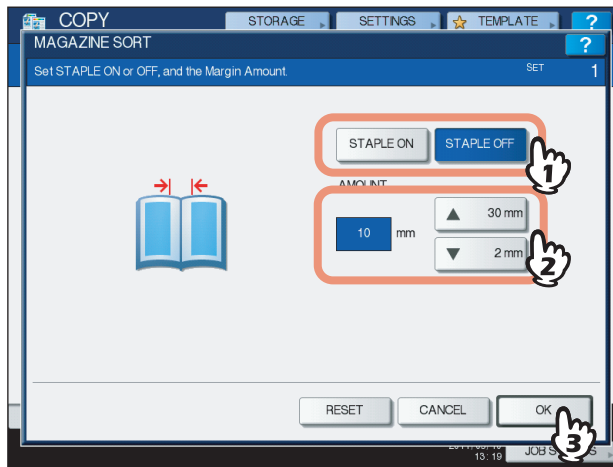

Tip

For the maximum number of sheets available for saddle stitching, see the following page:
 P.72 "Magazine sort / Center fold / Saddle stitch"

6 Select other copy modes as required, and then press the [START] button on the control panel.

Image Editing

You can select the various editing functions shown below for scanned images.

Trimming: You can select a certain area of an original and copy only the selected area.

Masking: You can mask a certain area of an original and copy only the unmasked area.

Mirror image: You can reverse an image like a mirror.

Negative/Positive reversal: You can reverse the light-and-dark of an image.

■ Trimming / Masking

You can select the desired area of an original and copy only the selected area (trimming). You can also mask the desired area of an original and copy only the unmasked area (masking). On both functions you can select up to 4 areas on 1 original. The selected area should be in a rectangle.

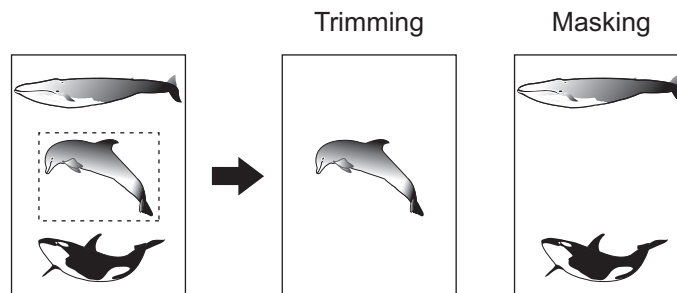

Tips

- Only standard size originals are applicable.
- Note that the entire image of the selected area may not be copied if you do not select proper sizes for the original and copy paper.

1 Place paper in the drawer(s).

When using bypass copying, be sure to set the paper size.

2 Press [EDITING] on the EDIT menu.

3 Select [TRIM] or [MASK].

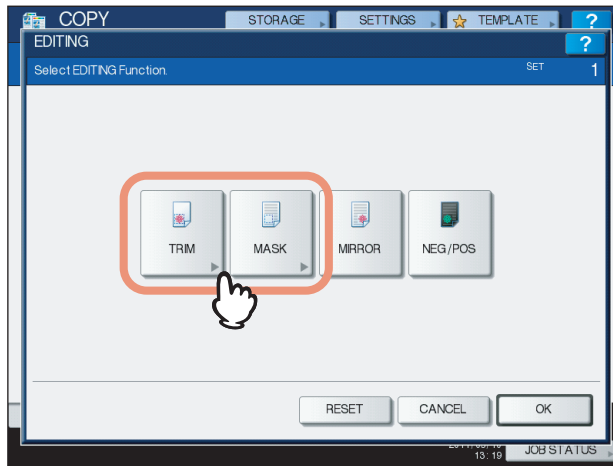

4

4 Place the original on the original glass with its face up.

Place it with its bottom toward you. Align its top left corner against that of the original glass so that the original will be aligned with the original scales.

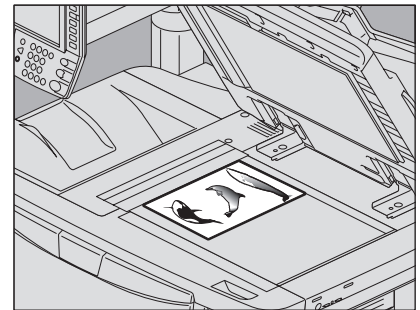

⚠ CAUTION

Do not place any heavy objects (4 kg (9 lb.) or over) on the original glass and do not press on it with force.

Breaking the glass could injure you.

5 Read the following 4 values to specify the area using the left and top scales on the original glass.

X1: From the top left to the left edge of the selected area

X2: From the top left to the right edge of the selected area

Y1: From the top left to the upper edge of the selected area

Y2: From the top left to the lower edge of the selected area

Note that the marks of the original scales have a 2 mm (0.08") pitch.

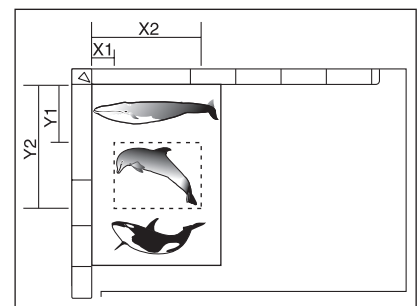

6 Key in the read values.

- 1) Press [X1], [X2], [Y1] and [Y2], and then key in the read values correspondingly.
- 2) You can specify up to 4 areas on 1 page. When you want to specify more than one area, press [AREA 1] to [AREA 4] to switch the area, and then key in the values correspondingly.
- 3) Press [OK] after you have specified all the areas.

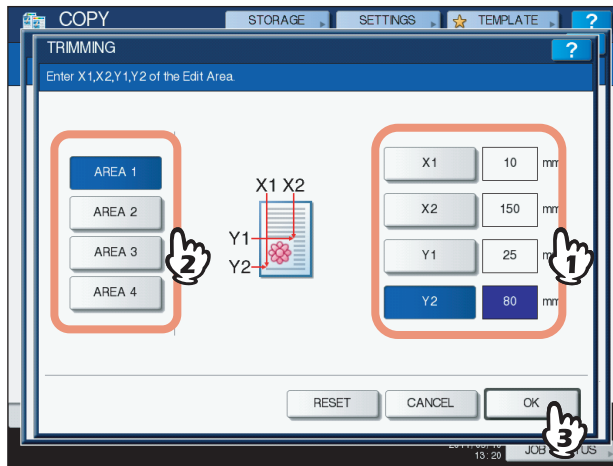

7 Place the original again on the original glass with its face down.

Place it with its bottom toward you. Align its top left corner against that of the original glass.

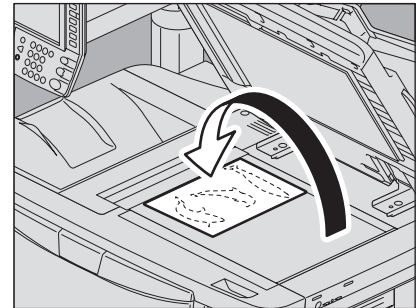

8 Select other copy modes as required, and then press the [START] button on the control panel.

■ Mirror image / Negative/positive reversal

You can reverse an image like a mirror (mirror image), or you can reverse light-and-dark of an image (negative/positive reversal).

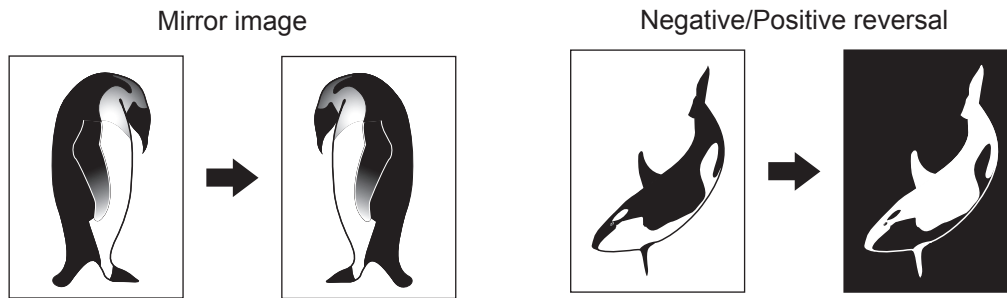

Note

Negative/positive reversal is available only when BLACK or FULL COLOR is selected as a color mode.

- 1 Place paper in the drawer(s).**
When using bypass copying, be sure to set the paper size.
- 2 Place the original(s).**
- 3 Press [EDITING] on the EDIT menu.**
- 4 Select [MIRROR] or [NEG/POS], and then press [OK].**

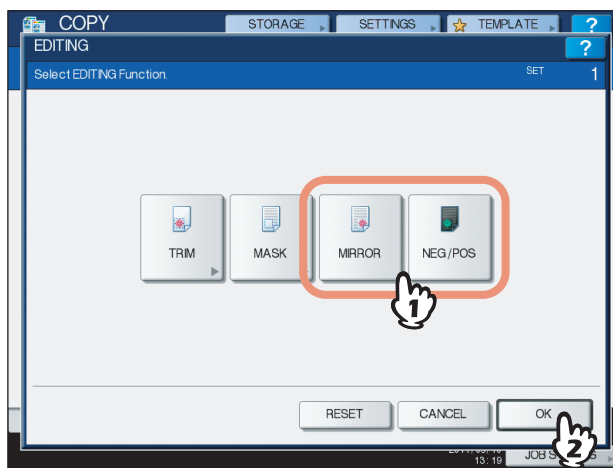

- 5 Select other copy modes as required, and then press the [START] button on the control panel.**

XY Zoom

You can change the reproduction ratio in both vertical and horizontal directions separately. This function is called “XY zoom”.

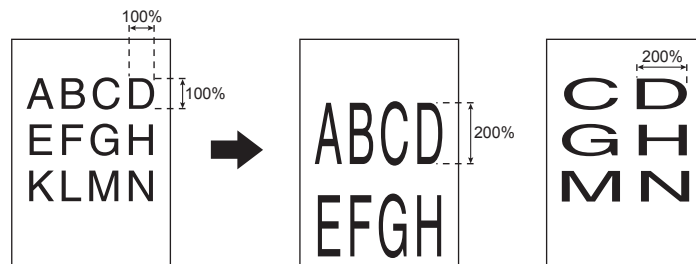

Note

The reproduction ratio is changeable from 25 to 400%. However in the following cases, this range is 25 to 200%.

- When the color mode is FULL COLOR or AUTO COLOR
- When the original mode is IMAGE SMOOTHING
- When the color mode is BLACK and the original mode is PHOTO
- When TWIN COLOR COPY is selected
- When MONO COLOR is selected
- When the original is placed on the RADF

1 Place paper in the drawer(s).

When using bypass copying, be sure to set the paper size.

2 Place the original(s).

3 Press [XY ZOOM] on the EDIT menu.

4 Set the reproduction ratio in both vertical and horizontal directions.

- 1) Press [X], and then press either [▼ 25%] or [▲ 400%] for a horizontal direction.
- 2) Press [Y], and then press either [▼ 25%] or [▲ 400%] for a vertical direction.
- 3) Press [OK].

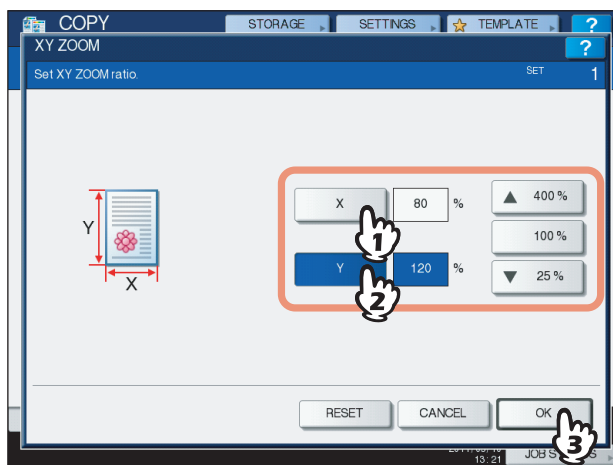

5 Select other copy modes as required, and then press the [START] button on the control panel.

Cover Sheet

You can add a special type of paper such as colored paper as a front cover sheet or a back cover sheet. This function is called "cover sheet". In the cover sheet mode, you can select whether or not to copy the front or back cover sheet as shown in the table below.

Front cover		Back cover	
Mode	Description	Mode	Description
NONE	Does not add a sheet as the front cover	NONE	Does not add a sheet as the back cover
BLANK	Adds a blank sheet as the front cover	BLANK	Adds a blank sheet as the back cover
TOP COPIED	Adds a sheet copied on the top side as the front cover	TOP COPIED	Adds a sheet copied on the top side as the back cover
BOTH COPIED	Adds a sheet copied on both sides as the front cover	BOTH COPIED	Adds a sheet copied on both sides as the back cover
		ONLY BACK COPIED	Adds a sheet copied on the back side as the back cover

4

Example: Selecting "TOP COPIED" for the front cover and "BLANK" for the back cover

A sheet copied on the top is added as the front cover and a blank sheet as the back cover.

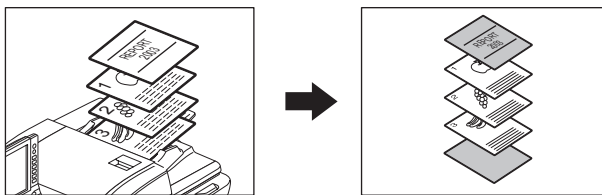

1 Place the paper for the cover sheets.

Place it on the bypass tray or in a drawer previously set for cover sheets. The paper for the cover sheets must be placed in a different paper source than normal paper.

Notes

- When placing paper in a drawer for cover sheets, be sure to select "COVER" as the paper type, and also set the paper size and thickness.
 P.17 "Setting paper type"
- When placing paper on the bypass tray, be sure to set the paper size and thickness.
 P.37 "Bypass Copying"
- Place the paper for cover sheets of the same size as normal paper in the same direction.

2 Place the normal paper in the drawer(s).

3 Place the original(s).

When placing them on the original glass, they must be placed from the first page.

4 Press [COVER SHEET] on the EDIT menu.

5 Select the front and back cover settings, and then press [OK].

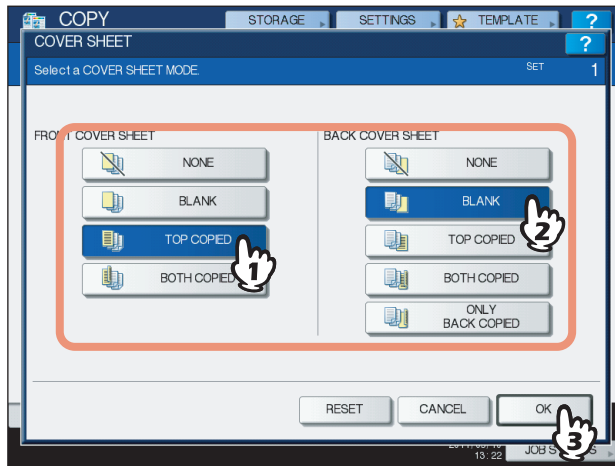

Tip

You can select [BOTH COPIED] for the front or back cover sheet only when [1->2 DUPLEX] or [2->2 DUPLEX] is set for the 2-sided copy mode on the basic menu.

6 Press the [BASIC] tab to display the BASIC menu. Then select a drawer in which normal paper is placed (not the one for the cover sheets).

You must place the normal paper of the same size and direction as that for the cover sheets in advance.

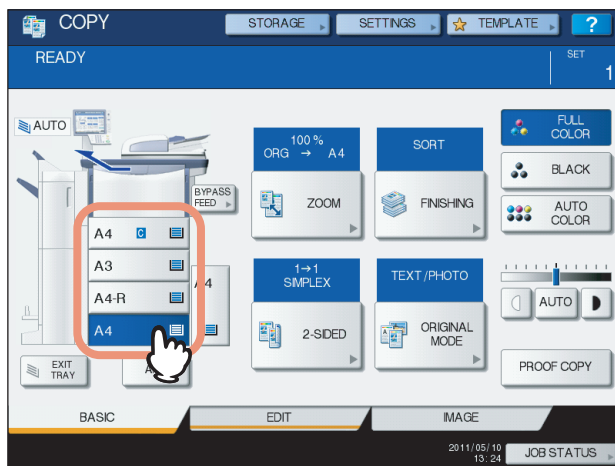

7 Select other copy modes as required, and then press the [START] button on the control panel.

When the originals are placed on the RADF, scanning and copying start.
When they are placed on the original glass, follow steps 8 and 9.

8 Place the next original, and then press [NEXT COPY] on the touch panel or the [START] button on the control panel.

Scanning of the next original starts. Repeat this procedure until the scanning of all the originals is finished.

9 When the scanning of all the originals is finished, press [JOB FINISH] on the touch panel.

Copying starts.

Sheet Insertion

You can insert a special type of paper such as colored paper at the desired page. This function is called “sheet insertion”. You can insert up to 2 types of sheets for a total of 50 pages. The sheet insertion mode has the following 2 types:

COPIED: Inserts a copied sheet, replacing the specified page.

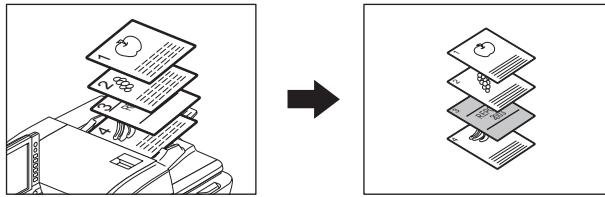

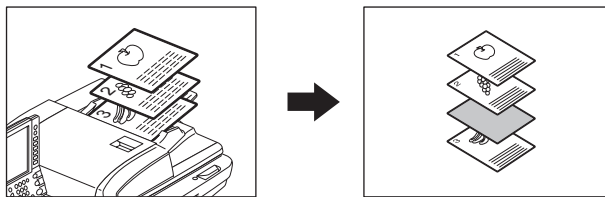

BLANK: Inserts a blank sheet before the specified page.



1 Place sheets for sheet insertion.

Place them on the bypass tray or in a drawer previously set for insertion sheets. The paper for the insertion sheets must be placed in a different paper source than normal paper.

Notes

- When placing paper in a drawer for sheet insertion, be sure to select “INSERT 1” or “INSERT 2” as a paper type, and also set the paper size and thickness.
 P.17 “Setting paper type”
- When placing paper on the bypass tray, be sure to set the paper size and thickness.
 P.37 “Bypass Copying”
- Place the paper for insertion sheets of the same size as normal paper in the same direction.

2 Place the normal paper in the drawer(s).

3 Place the original(s).

When placing them on the original glass, they must be placed from the first page.

4 Press [SHEET INSERTION] on the EDIT menu.

5 Select either [COPIED] or [BLANK].

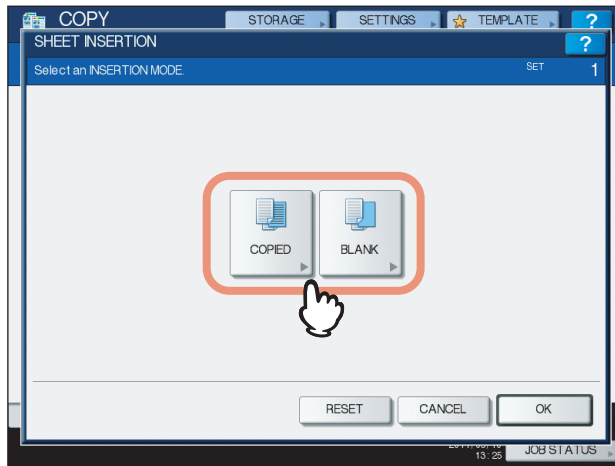

6 Select the page where the insertion sheets will be inserted.

- 1) Select the type of the insertion sheets ([INSERT SOURCE 1] or [INSERT SOURCE 2]).
- 2) Key in page numbers (1 to 1000) where the insertion sheets will be inserted, and then press [SET]. Repeat steps 1) and 2) if you want to insert sheets at more than one page.
- 3) Press [OK] after you have keyed in the page numbers.

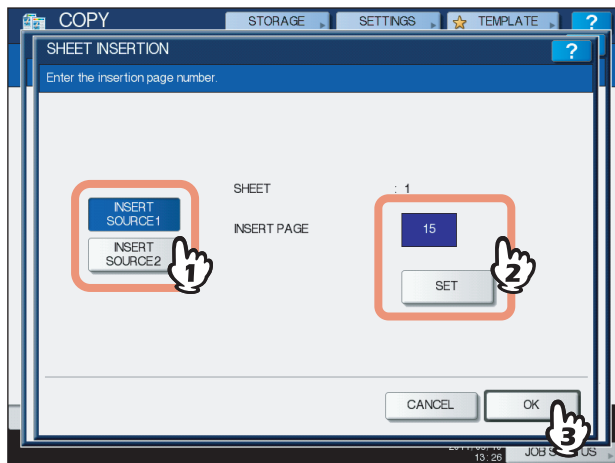

Tips

- If you selected [COPIED] in step 5, the selected page will be replaced with a copied insertion sheet. If you selected [BLANK], a blank insertion sheet will be inserted before the selected page.
- Up to 50 pages in total can be selected for [INSERT SOURCE 1] and [INSERT SOURCE 2].

7 Press the [BASIC] tab to display the BASIC menu. Then select the drawer in which normal paper is placed (not the one for sheet insertion).

You must place the normal paper of the same size and direction as that for the insertion sheets in advance.



4

8 Select other copy modes as required, and then press the [START] button on the control panel.

When the originals are placed on the RADF, scanning and copying start.

When they are placed on the original glass, follow steps 9 and 10.

9 Place the next original, and then press [NEXT COPY] on the touch panel or the [START] button on the control panel.

Scanning of the next original starts. Repeat this procedure until the scanning of all the originals is finished.

10 When the scanning of all the originals is finished, press [JOB FINISH] on the touch panel.

Copying starts.

Time Stamp

You can add the date and time on the copied paper.

Printed at the bottom
of a portrait copy

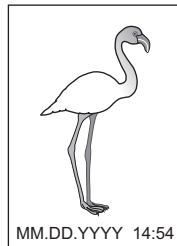

Printed at the top
of a landscape copy



- 1** Place paper in the drawer(s).
- 2** Place the original(s).
- 3** Press [TIME STAMP] on the EDIT menu.
- 4** Select the direction and position of the time stamp.
 - 1) Select the direction ([SHORT EDGE] or [LONG EDGE]).
 - 2) Select the position ([UPPER] or [LOWER]).
 - 3) Press [OK].

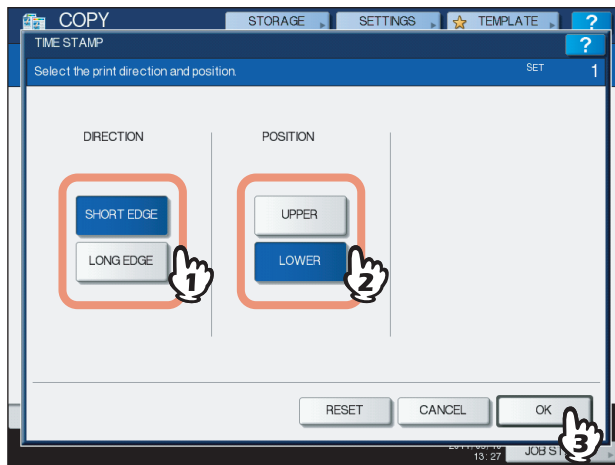

- 5** Select other copy modes as required, and then press the [START] button on the control panel.

Page Number

You can add a page number on the copied paper.

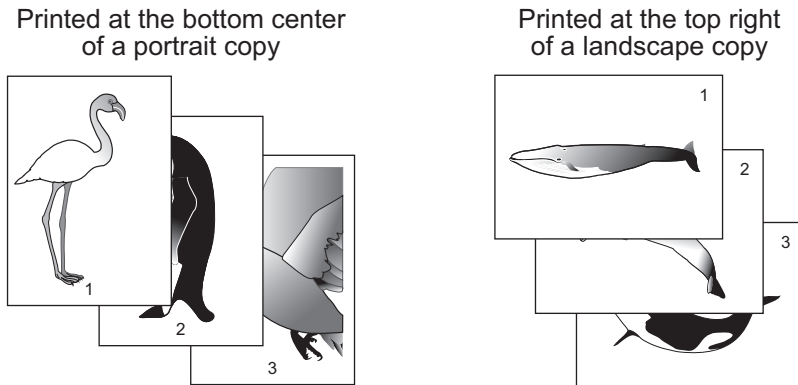

- 1 Place paper in the drawer(s).**
- 2 Place the original(s).**
- 3 Press [PAGE NUMBER] on the EDIT menu.**
- 4 Select the direction and position of a page number.**
 - 1) Select the direction ([SHORT EDGE] or [LONG EDGE]).
 - 2) Select the position ([TOP LEFT], [TOP CENTER], etc.).
 - 3) If you want to specify the page number to start with, press and go to step 5. Otherwise, press [OK] and go to step 6.

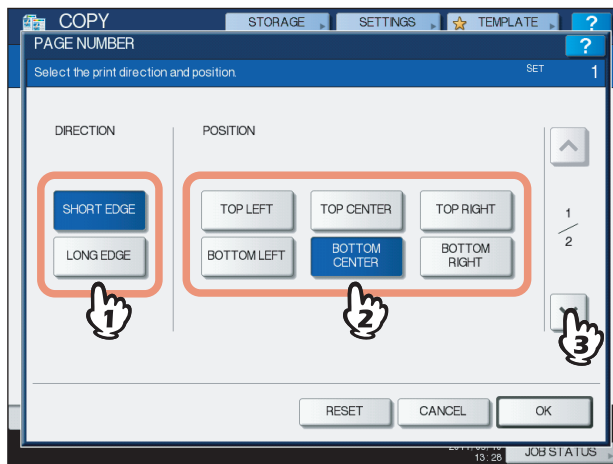

5 Specify the page number you want to start with.

- 1) Key in the page number.
- 2) Press [OK].

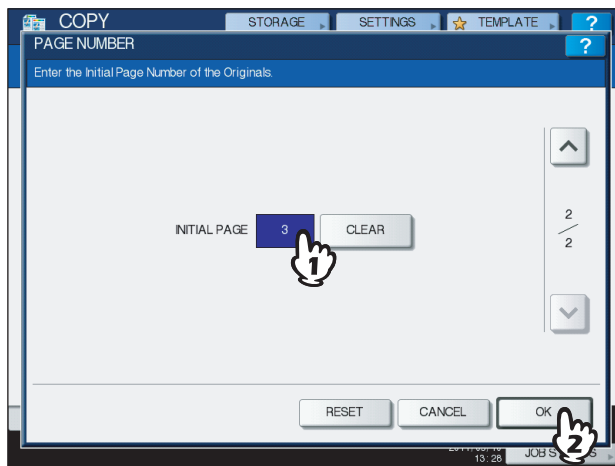

Tip

You can specify the initial page from 1 to 32766.

6 Select other copy modes as required, and then press the [START] button on the control panel.

Job Build

You can scan several stacks of originals whose settings are individually different, and then copy or store them in one operation. This function is called "job build". For example, news clips (in the TEXT mode) and photographs in magazines (in the PHOTO mode) in A3 size and photographs in A4 size can be scanned in the optimal settings for each, and copied in one operation.

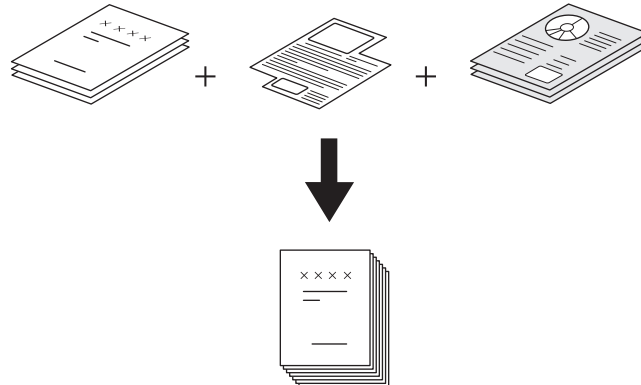

Notes

- Up to 1000 pages of originals can be copied in one operation. There is no limit for the number of jobs.
- Some settings are not available for job build, and some settings for the first job will be applied to all of the other jobs. See the table below before setting job build.

Settings not available	Settings applied for all jobs	Settings changeable for each job
Automatic Paper Selection BOOK -> 2 (Book-type original -> 2-sided copy) Twin color copying Editing XY zoom Cover sheet Sheet insertion Magazine sort Magazine sort & saddle stitch Magazine sort & center fold 2IN1 / 4IN1 Full image Image repeat	e-Filing / File Mixed-size originals Copy paper size Finishing mode Photo zoom Image shift Book center erase Time stamp Page number Image direction Book - tablet Omit blank page	Reproduction ratio Automatic Magnification Selection (Default setting for job build) Original size Original mode Color mode Simplex/Duplex copying settings other than Book-type original -> 2-sided copy (1->1 SIMPLEX, 2->1 SPLIT, 1->2 DUPLEX, 2->2 DUPLEX) Background adjustment Sharpness Edge erase Dual page Document feeder (Feeding mode) Outside erase

- 1 Press [JOB BUILD] on the EDIT menu.

2 Press [OK].

Job build is now set and the message below appears.



3 Place the first stack of originals, and then select settings.

Tips

- When placing the original on the original glass, remember that 1 page is equal to 1 job.
- When placing mixed-size originals on the RADF, see the following page:
 P.52 "Copying mixed-size originals in one operation"
- If you want to use a particular drawer, select it.

Notes

- Press [SETTINGS] on the touch panel to confirm the current settings.
- If you want to change the settings, press the [FUNCTION CLEAR] button on the control panel, and then restart the procedure from step 1.

4 Press the [START] button on the control panel.

Scanning starts. When the scanning of all the originals is finished, the message below appears.

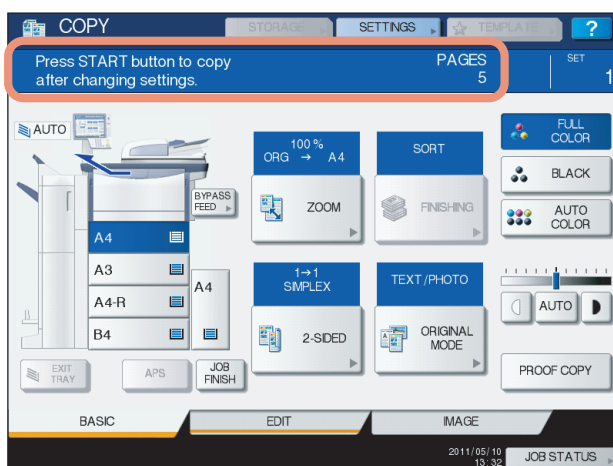

5 Place the next stack of originals, and then select the settings.

Repeat steps 4 and 5 until all the desired pages have been scanned.

Note

If you do not change any settings, those for the last job will be applied.

6 When the scanning of all the originals is finished, change the number of copy sets as required. Then press [JOB FINISH] on the touch panel.



Copying starts. If any storing function is set, that will also start.

Image Direction

When you make 1-sided portrait originals to 2-sided copy by placing them in a landscape direction, normally the copied pages are "open to top". With this function you can make them "open to left". This function is called "image direction". When you make 2-sided "open to left" portrait originals to 1-sided copy, normally the copied pages exit in a different direction alternately. With this function, you can make them all exit in the same direction.

1-sided portrait original (placed in a landscape direction) -> 2-sided copy

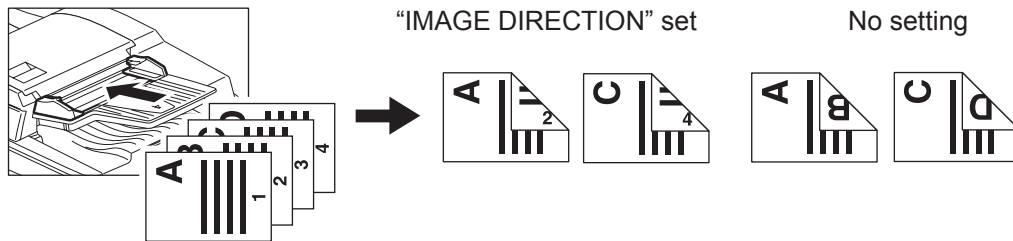

2-sided "open to left" portrait original -> 1-sided copy

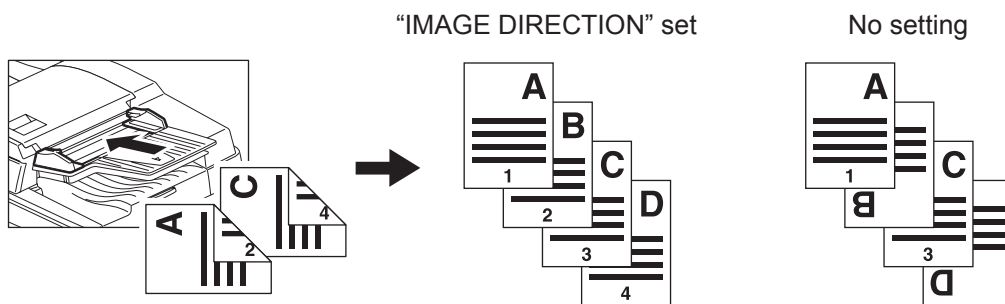

- 1** Place paper in the drawer(s).
- 2** Place the original(s).
- 3** Set duplex copying setting.
 P.77 "Duplex Copying"
- 4** Press [IMAGE DIRECTION] on the EDIT menu.
- 5** Press [OK].
Image direction is now set.
- 6** Select other copy modes as required, and then press the [START] button on the control panel.

Book - Tablet

As for the directions of originals or copied images, “open to left” is called “book” and “open to top” is called “tablet”. To make 1-sided originals to 2-sided copies, you can choose “tablet” or “book” copy. To make 2-sided originals to 2-sided copies, you can switch “book” originals to “tablet” copies, and vice versa.

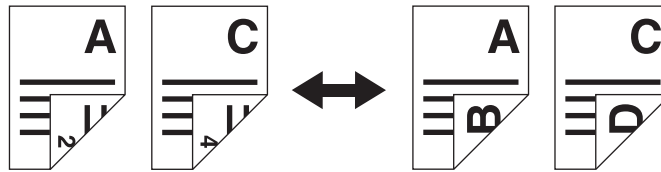

- 1** Place paper in the drawer(s).
- 2** Place the original(s).
- 3** Press [BOOK <->TABLET] on the EDIT menu.
- 4** Press [OK].
Book - tablet is now set.
- 5** Select other copy modes as required, and then press the [START] button on the control panel.

ADF -> SADF

You can switch the feeding mode when the RADF (Reversing Automatic Document Feeder) is used, from “ADF” to “SADF”. The paper feeding mode has 2 types as follows:

ADF (Continuous feed mode): Feeds originals continuously when you press the [START] button on the control panel while originals are being placed on the RADF. This is useful when you make more than one copy in one operation. (Default setting)

SADF (Single feed mode): Feeds originals one by one automatically. This is useful when you usually only have 1 original.

Note

When the single feed mode (SADF) is set, place originals one sheet at a time. If you place more than one original, the copied image may be skewed or the originals may misfeed.

- 1 Place paper in the drawer(s).**
- 2 Press [ADF -> SADF] on the EDIT menu.**
- 3 Press [OK].**
The feeding mode is now set at “single feed mode”.
- 4 Select other copy modes as required.**
- 5 Place the original(s) on the RADF one sheet at a time.**
The original is pulled into the RADF automatically, and then the menu below appears.

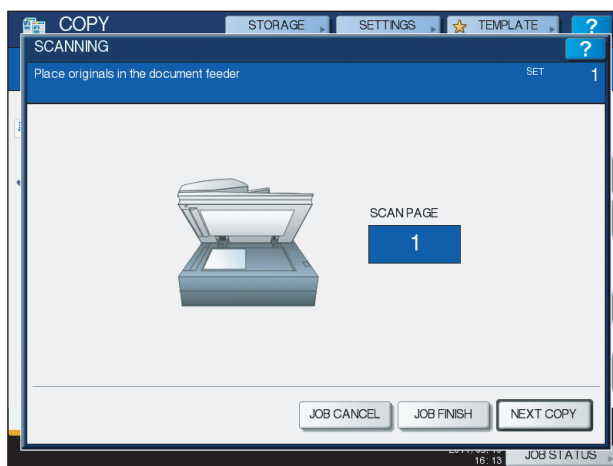

Repeat step 5 if you have another original. The placed original will be pulled into the RADF automatically even if you do not press [NEXT COPY] on the touch panel.

- 6 When the scanning of all the originals is finished, press [JOB FINISH].**

Tip

If you want to stop copying, press [JOB CANCEL].

Full Image

You can copy the entire image of an original including any fine text at its edge. This function is called “full image”. With this function, the image will be copied with its reproduction ratio reduced by approx. 1 to 5%.

- 1 Place paper in the drawer(s).**
- 2 Place the original(s).**
- 3 Press [ZOOM] on the touch panel.**
- 4 Select sizes for the original and copy paper.**
 - 1) Select the original size.
 - 2) Select the paper size.
 - 3) Press [OK].

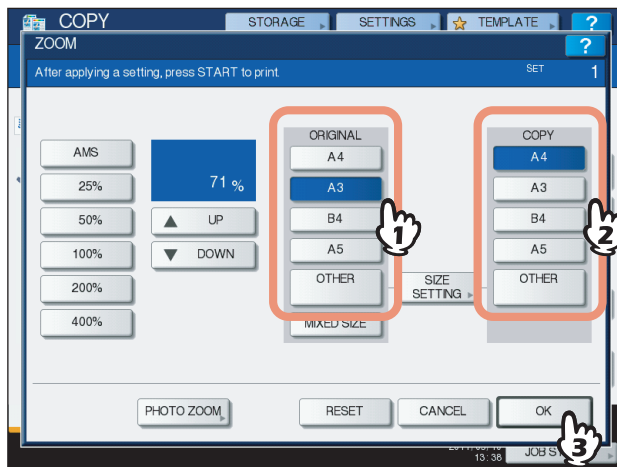

The menu returns to the BASIC menu.

- 5 Press [FULL IMAGE] on the EDIT menu.**
- 6 Select other copy modes as required, and then press the [START] button on the control panel.**

Image Repeat

You can copy a certain area on an original repeatedly in the times that you specified. This function is called "image repeat".

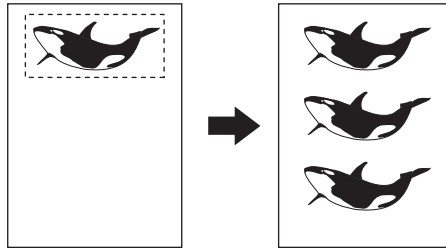

Tips

- You can repeat copying up to 8 times.
- Only standard size originals are available.

Note

When registering this function into a template, be sure to select [DISABLE] of "AUTOMATIC START". If [ENABLE] is selected, copies may not be made correctly because the original size is not detected.

📖 P.145 "TEMPLATES"

1 Place paper in the drawer(s).

When using bypass copying, be sure to set the paper size.

2 Press [IMAGE REPEAT] on the EDIT menu.

3 Place the original on the original glass with its face up.

Place it with its bottom toward you. Align its top left corner against that of the original glass so that the original will be aligned with the original scales.

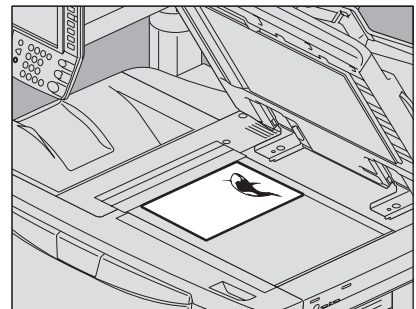

⚠ CAUTION

Do not place any heavy objects (4 kg (9 lb.) or over) on the original glass and do not press on it with force.

Breaking the glass could injure you.

4 Read the following 4 values to specify the area using the left and top scales on the original glass.

- X1:** From the top left to the left edge of the selected area
- X2:** From the top left to the right edge of the selected area
- Y1:** From the top left to the upper edge of the selected area
- Y2:** From the top left to the lower edge of the selected area

Note that the marks of the original scale have a 2 mm (0.08") pitch.

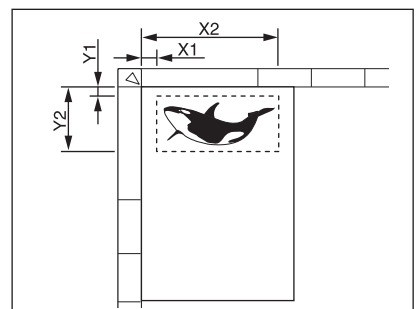

5 Key in the read values and specify the repeat count.

- 1) Press [X1], [X2], [Y1] and [Y2], and then key in the read value correspondingly.
- 2) Change the number of times you repeat the image (repeat count) by pressing either [▼ 2] or [▲ 8].
- 3) Press [OK].

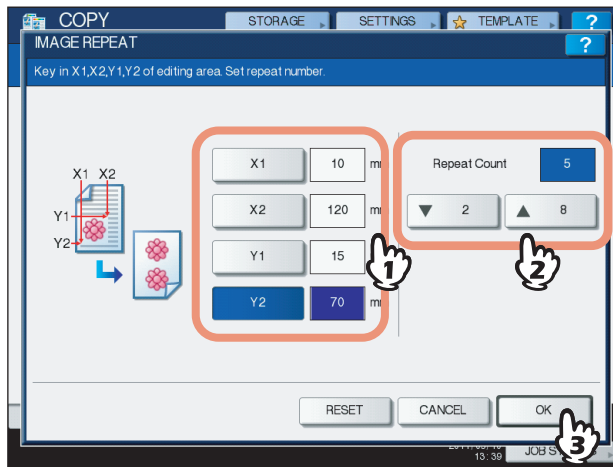

Notes

- The selected area will be copied from the top right corner in a vertical direction.
- If the repeated image runs over the paper size, that part will not be copied.

6 Place the original again on the original glass with its face down.

Place with its bottom toward you. Align its top left corner against that of the original glass.

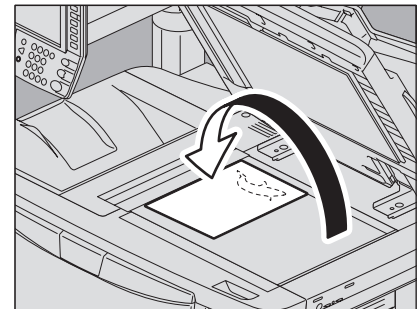

7 Select other copy modes as required, and then press the [START] button on the control panel.

Omit Blank Page

You can remove blank sheets included in the scanned originals before copying is started. This function is called “omit blank page”.

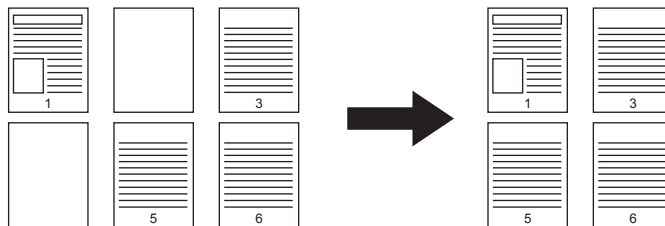

Notes

- This function may not properly detect blank sheets included in the following types of originals:
 - Half-tone originals
 - Originals including sheets almost blank (e.g. blank pages having only page numbers)
- If you copy 2-sided originals including blank sheets to 2-sided copy while this function is enabled, the front and back sides of the originals and the copies will not match.

Tip

The sensitivity to detect blank pages can be changed. For details, refer to the *MFP Management Guide*.

1 Place paper in the drawer(s).

When using bypass copying, be sure to set the paper size.

2 Place the original(s).

3 Press [OMIT BLANK PAGE] on the EDIT menu.

4 Press [OK].

Omit blank page is now set.

5 Select other copy modes as required, and then press the [START] button on the control panel.

Scanning and copying start. A message notifying you of the number of the blank sheets appears for approx. 5 seconds.

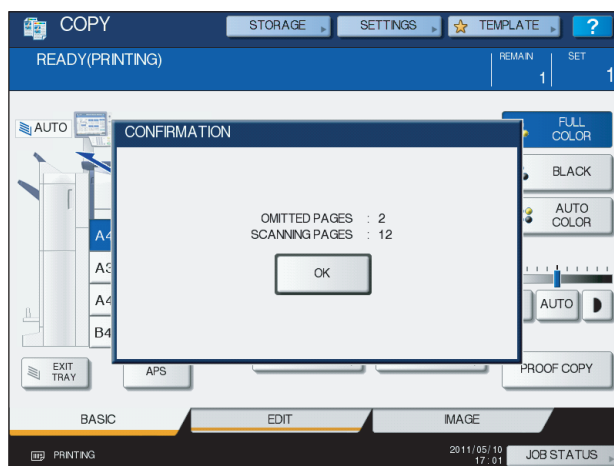

Outside Erase

You can whiten a shadow-like dark part which has appeared outside of the copied image; this has been caused by a gap between the original glass and the platen sheet. This function is called “outside erase”. It is useful when you place thick originals such as booklets on the original glass.

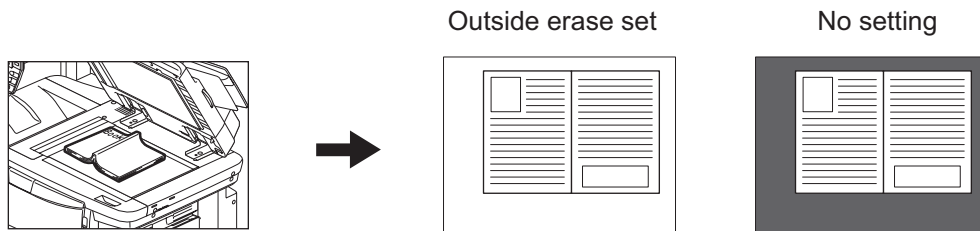

Notes

- This function is disabled when you place originals on the RADF or you place them on the original glass with the RADF closed fully.
- When this function is enabled, the automatic density adjustment is disabled. Adjust the density level manually.
- Originals with an intricate outer shape (e.g. an original with cut-out parts on its edge) may not be copied properly because this function may not detect the border between the original and areas not belonging to it.

1 Place paper in the drawer(s).

When using bypass copying, be sure to set the paper size.

2 Select the drawer for the desired paper size.



3 Press [OUTSIDE ERASE] on the EDIT menu.

4 Set “outside erase”.

- 1) Press [ON].
- 2) Adjust the width of the border around the original by pressing either \ominus or \oplus as required.
 - When you adjust it to the \oplus side, the area to be detected as not belonging to the original is widened.
 - When you adjust it to the \ominus side, the area to be detected as not belonging to the original is narrowed.

3) Press [OK].

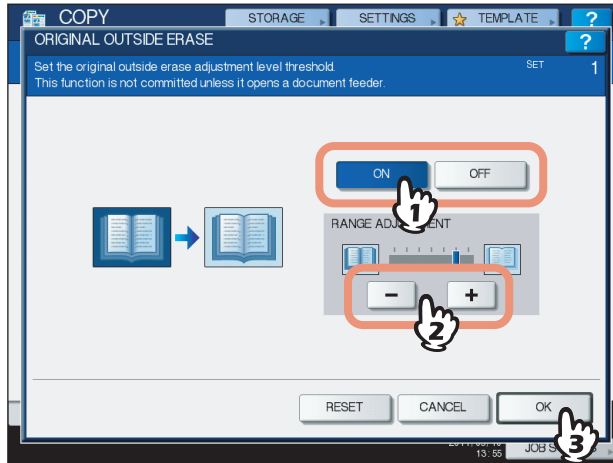

5 Place the original on the original glass.

Notes

- When placing the original, be sure that the RADF is fully raised. If not, this function may not properly be able to detect the border between the original and areas not belonging to it.
- Do not directly look at the original glass during copying since an intense light may leak.

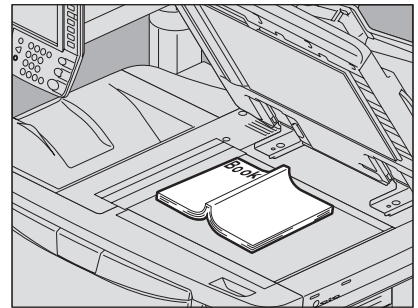

⚠ CAUTION

Do not place any heavy objects (4 kg (9 lb.) or over) on the original glass and do not press on it with force.

Breaking the glass could injure you.

6 Select other copy modes as required, and then press the [START] button on the control panel.

IMAGE ADJUSTMENT

This chapter describes the image adjustment functions allowing you to change the overall color balance of a copied image, copy an original in a specified color, and so on.

Displaying IMAGE Menu	128
Using Image Adjustment Functions	129
Color balance (YMCK adjustment)	129
RGB adjustment	131
One-touch adjustment	132
Background adjustment	133
Sharpness	134
Twin color copying	135
Mono color copying	140
Hue	141
Saturation	142
ADF Scan Noise Reduction	143

Displaying IMAGE Menu

You can display the IMAGE menu by pressing the [IMAGE] tab on the touch panel when you want to use various image adjustment functions.

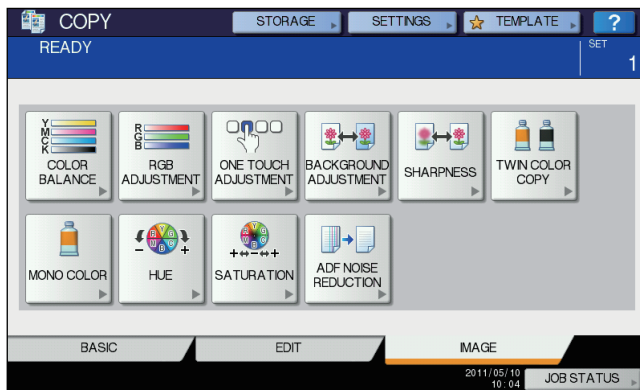
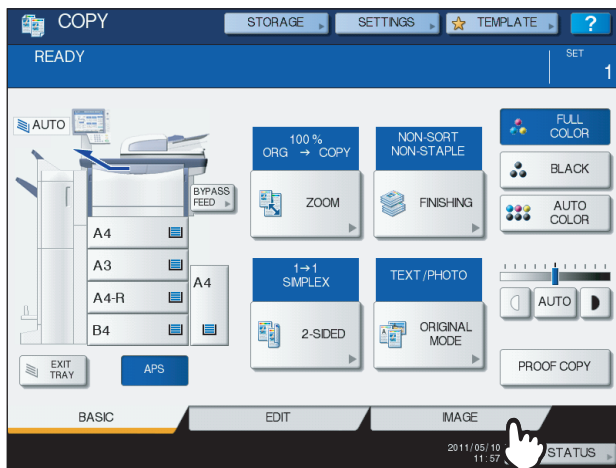

Using Image Adjustment Functions

■ Color balance (YMCK adjustment)

This function allows you to adjust the overall color balance of the copied image by changing the strength of YELLOW (Y), MAGENTA (M), CYAN (C) and BLACK (K). This function is available in the full color mode or the auto color mode.

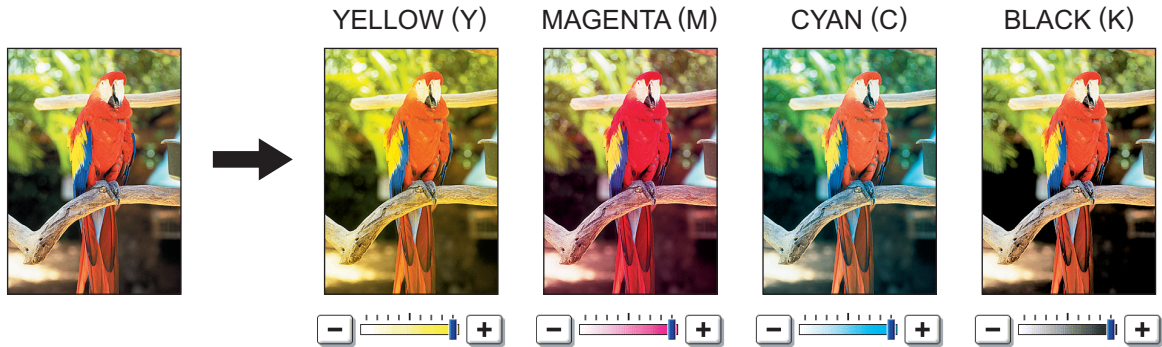

5

- 1 Press [COLOR BALANCE] in the IMAGE menu.
- 2 Press **-** or **+** of each color to obtain the desired color balance.

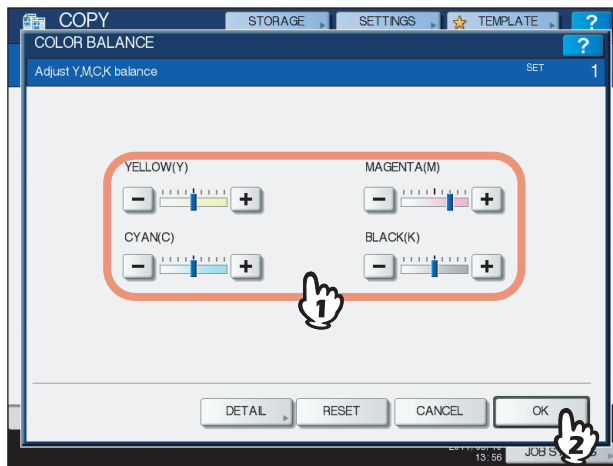

After completing the color balance adjustment, press [OK]. This is the end of the setting.
If you want to adjust each color balance on every density area, press [DETAIL] and go to the next step.

3 Press **-** or **+** of the color on each density area to obtain the desired color balance.

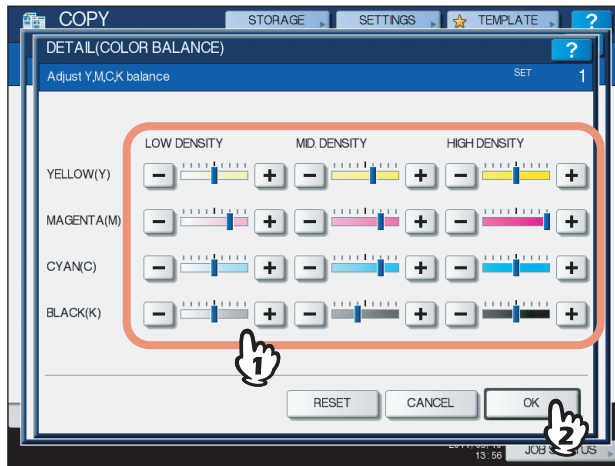

For example, when you adjust the high density area of magenta (M) to the **+** side, the magenta in its high density area becomes darker.

After completing the adjustment, press [OK].

Canceling color balance adjustment

- Move the indicator of the color whose adjustment you want to cancel to the middle, and then press [OK].
- If you want to cancel the adjustment of all colors, press [RESET], and then [OK].

■ RGB adjustment

This function allows you to adjust the overall color balance of the copied image by changing the strength of RED (R), GREEN (G) and BLUE (B). This function is available in the full color mode or the auto color mode.

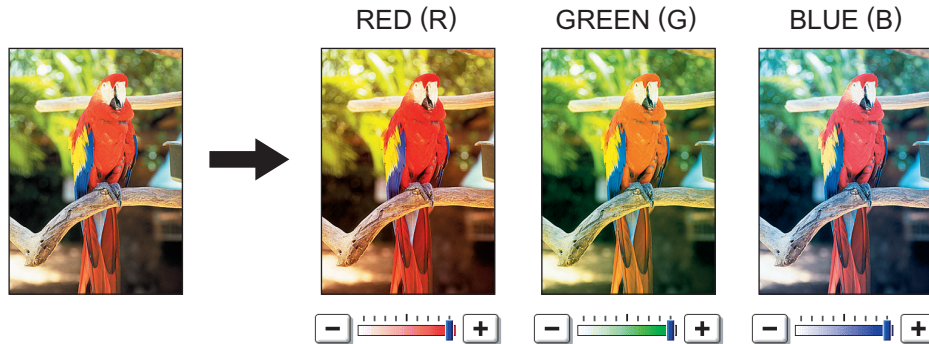

5

- 1 Press [RGB ADJUSTMENT] in the IMAGE menu.
- 2 Press **-** or **+** of the color to obtain the desired color balance, and then press [OK].

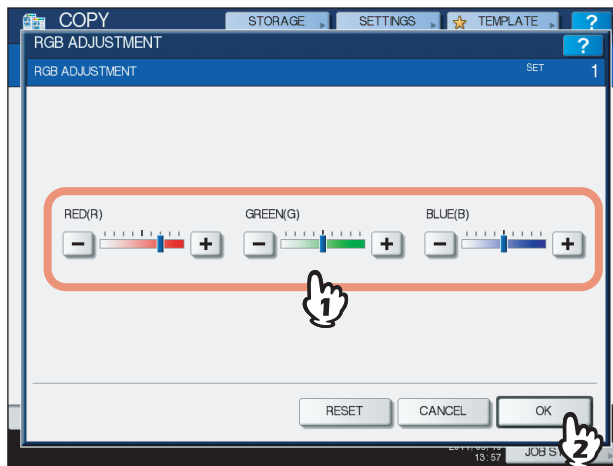

Canceling RGB adjustment

- Move the indicator of the color whose adjustment you want to cancel to the middle, and then press [OK].
- If you want to cancel the adjustment of all colors, press [RESET], and then [OK].

■ One-touch adjustment

This function allows you to obtain the image quality already registered in this equipment. You can select the image quality from “WARM”, “COOL”, “VIVID”, “CLEAR” and “MARKER”. This function is available only in the full color mode.

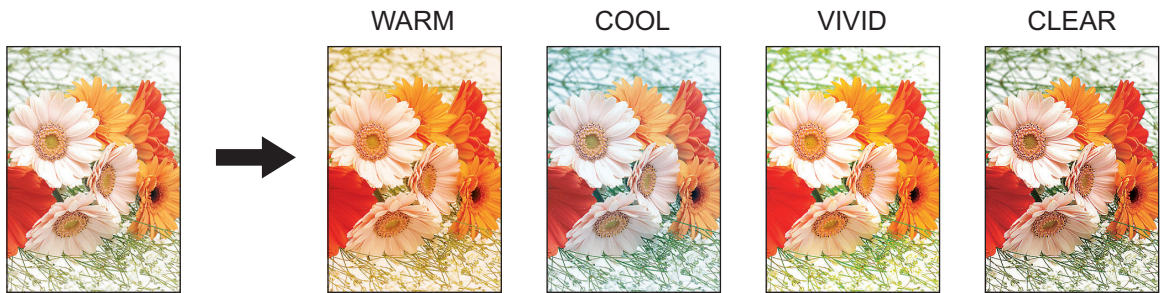

When [MARKER] is selected

Multiple colors drawn with a highlight pen on the original can be copied so as to be distinguished clearly; however, the color shade may not be the same as that of the original depending on the color of the highlight pen.

- 1 Press [ONE TOUCH ADJUSTMENT] in the IMAGE menu.
- 2 Select the image quality, and then press [OK].

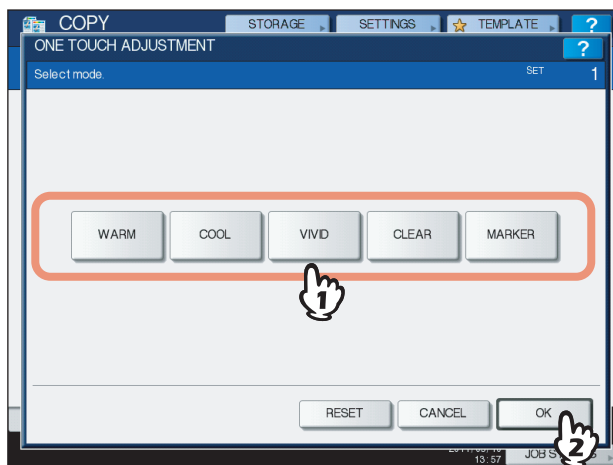

Canceling one-touch adjustment

Press [RESET].

■ Background adjustment

This function allows you to adjust the density of the original's background. It avoids the back side of a 2-sided original becoming visible on its front side.

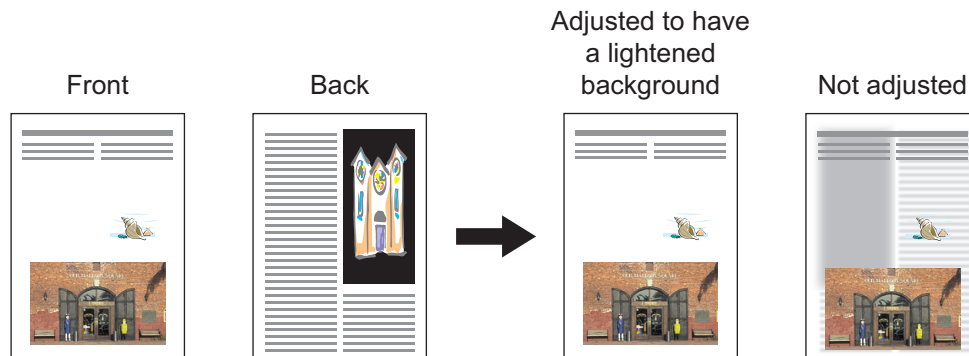

Note

This mode cannot be used with the automatic density adjustment function.
 P.56 "Density Adjustment"

- 1 Press [BACKGROUND ADJUSTMENT] in the IMAGE menu.
- 2 Press [LIGHT] or [DARK] to adjust the density, and then press [OK].

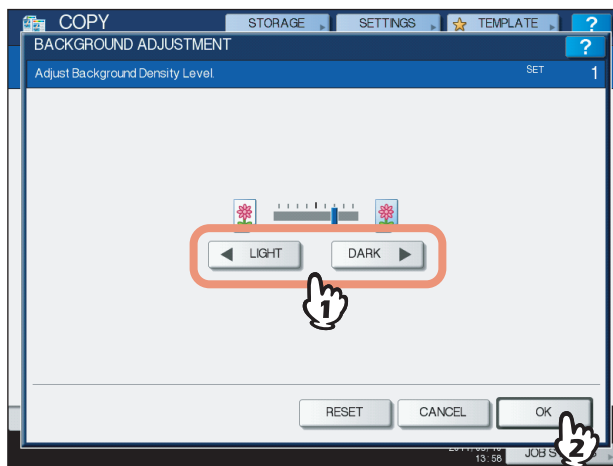

Canceling background adjustment

- Move the indicator to the middle, and then press [OK].
- Press [RESET] and then [OK].

■ Sharpness

This function allows you to emphasize or blur the outline of the image.

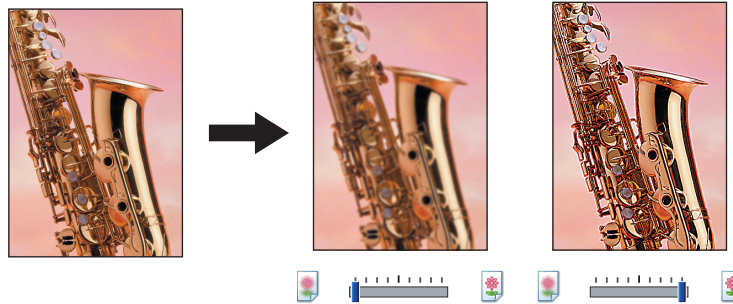

1 Press [SHARPNESS] in the IMAGE menu.

2 Press [SOFT] or [SHARP] to adjust the sharpness, and then press [OK].

When the sharpness level is adjusted to the [SOFT] side, the moire fringes on the printed photos, etc. are softened. If it is adjusted to the [SHARP] side, the letters and fine lines become sharper.

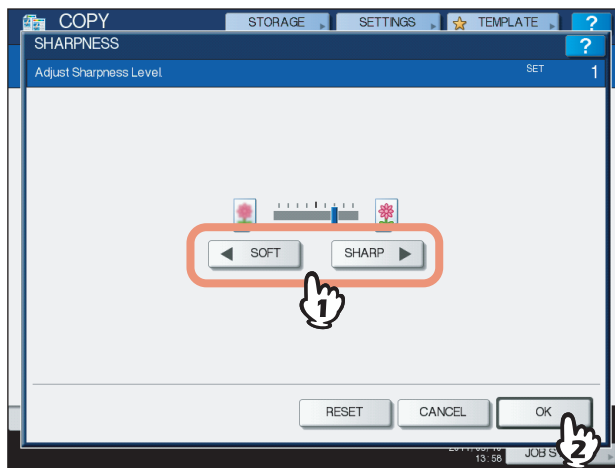

Canceling sharpness adjustment

- Move the indicator to the middle, and then press [OK].
- Press [RESET] and then [OK].

■ Twin color copying

This function allows you to copy a colored original in 2 specified colors. There are 2 types of twin color copying as follows:

TWIN COLOR SELECTABLE: The black part and the parts other than black in the original are copied in 2 specified colors.



RED & BLACK: The red part in the original is copied in red and the parts other than red are copied in black and white.

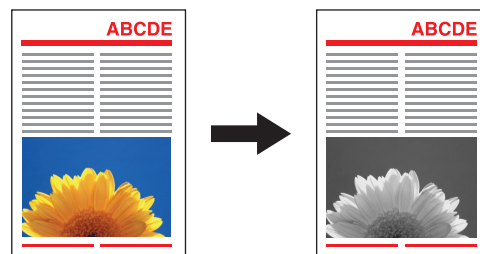

Note

The color may not be correctly reproduced in some originals. In that case, copy them in the full color mode.

□ Twin color selectable

- 1 Press [TWIN COLOR COPY] in the IMAGE menu.
- 2 Press [TWIN COLOR SELECTABLE].

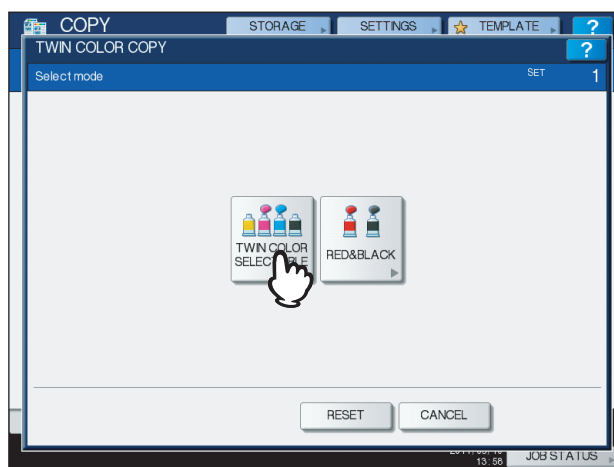

3 Select a color for the parts other than black in the original.

- 1) Press [SECOND COLOR].
- 2) Select the desired color.

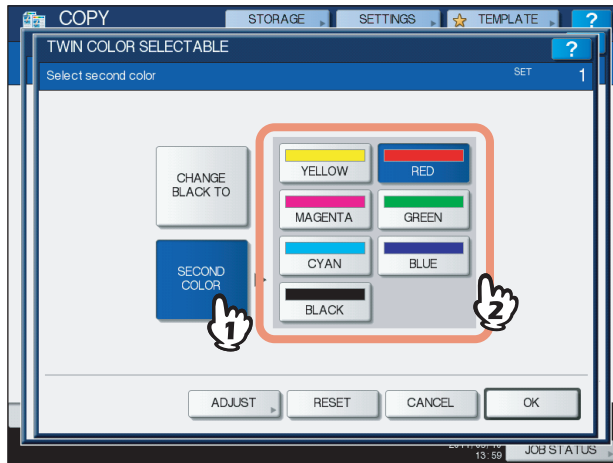

4 Select a color for the black part in the original.

- 1) Press [CHANGE BLACK TO].
- 2) Select the desired color.

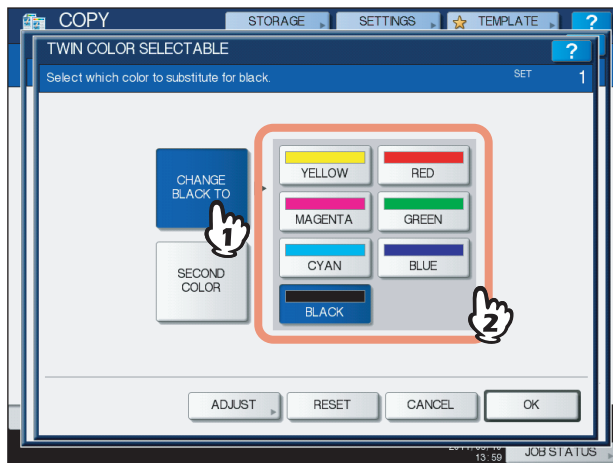

After selecting the color, press [OK]. This is the end of the setting.

If you want to adjust the color balance, press [ADJUST] and go to the next step.

Notes

- When the two colors specified are the combination of black and a color other than black, color balance adjustment is enabled. When neither of the two colors is black, or when both of them are black, this adjustment is disabled.
- The color balance of a color other than black can be adjusted.

5 Press **-** or **+** of the color to obtain the desired color balance.

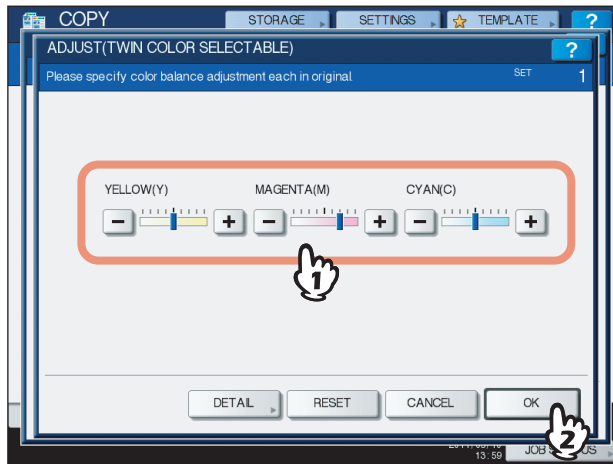

After completing the adjustment, press [OK]. This is the end of the setting.
If you want to adjust each color balance on every density area, press [DETAIL] and go to the next step.

6 Press **-** or **+** of the color on each density area to obtain the desired color balance.

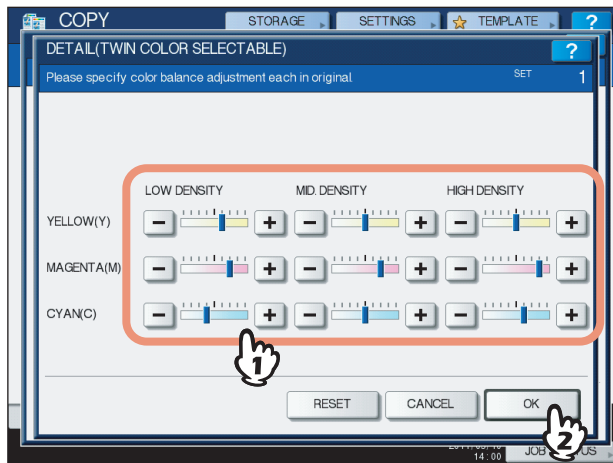

For example, when you adjust the high density area of magenta (M) to the **+** side, the magenta in its high density area becomes darker.

After completing the adjustment, press [OK].

Canceling color balance adjustment

- Move the indicator of the color whose adjustment you want to cancel to the middle, and then press [OK].
- If you want to cancel the adjustment of all colors, press [RESET], and then [OK].

□ RED & BLACK

1 Press [TWIN COLOR COPY] in the IMAGE menu.

2 Press [RED & BLACK].

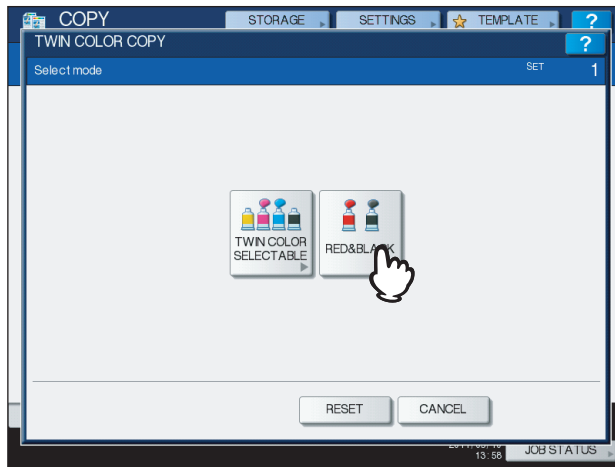

3 To adjust the red color or the red-and-black area, press [ADJUST]. If you do not want to adjust the color, press [OK].

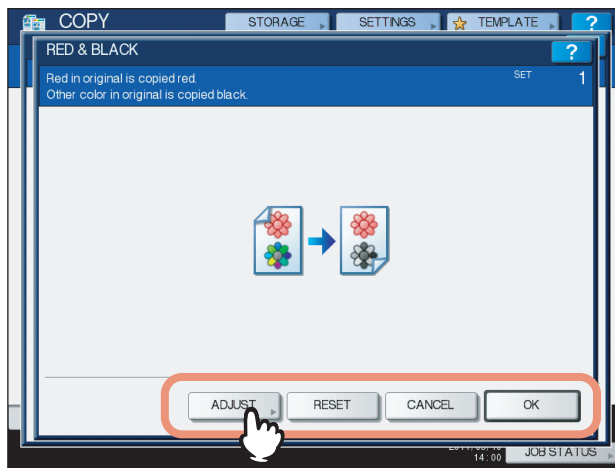

If you do not adjust the red color or the red-and-black area, this is the end of the setting.
If you want to adjust it, go to the next step.

4 Adjust the red color or the red-and-black area.

Red in original

Press **-** or **+** of yellow or magenta to adjust the red color balance.

Range Adjustment

Press **◀** or **▶** to adjust the red-and-black area. When you set the red area to be larger, the area to be copied in red becomes larger. When you set the black area to be larger, the area to be copied in black becomes larger.

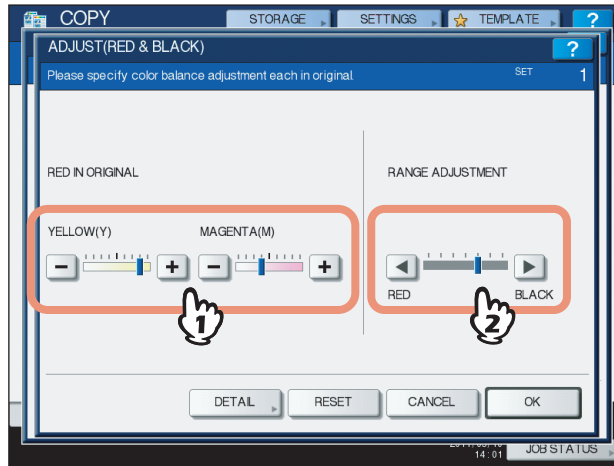

After completing the adjustment, press [OK]. This is the end of the setting.

If you want to adjust color balance of yellow and magenta on every density area, press [DETAIL] and go to the next step.

5 Press **-** or **+** on each density area to obtain the desired color balance.

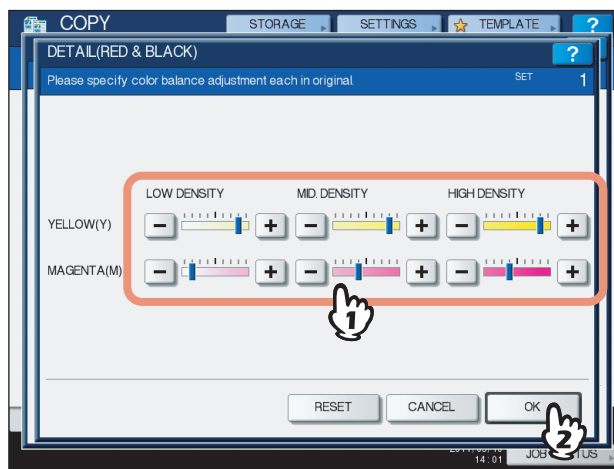

For example, when you adjust the high density area of magenta (M) to the **+** side, the magenta in its high density area will become darker.

After completing the adjustment, press [OK].

Canceling color balance adjustment

- Move the indicator of the color whose adjustment you want to cancel to the middle, and then press [OK].
- If you want to cancel the adjustment of all colors, press [RESET], and then [OK].

■ Mono color copying

This function allows you to make copies in a single color except black.

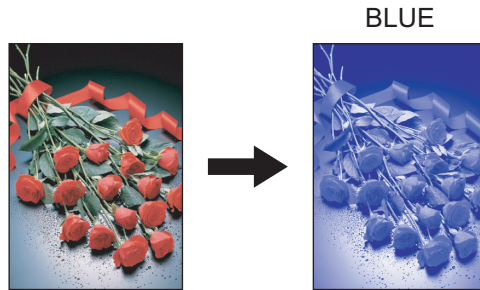

- 1 Press [MONO COLOR] in the IMAGE menu.
- 2 Press the button corresponding to the desired color.

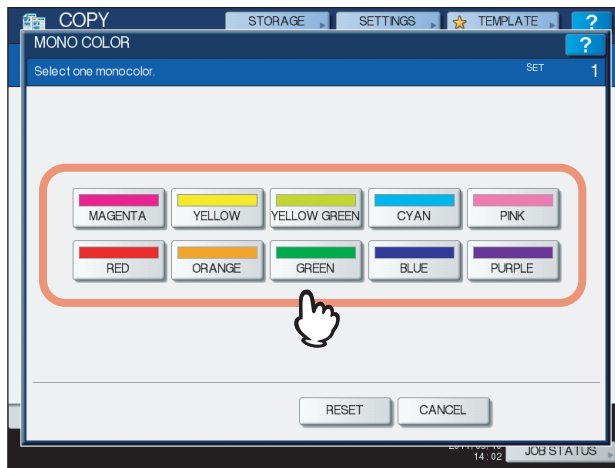

Canceling mono color copying

Press [RESET].

■ Hue

This function allows you to adjust the hue of the basic color. This function is available in the full color mode or the auto color mode.

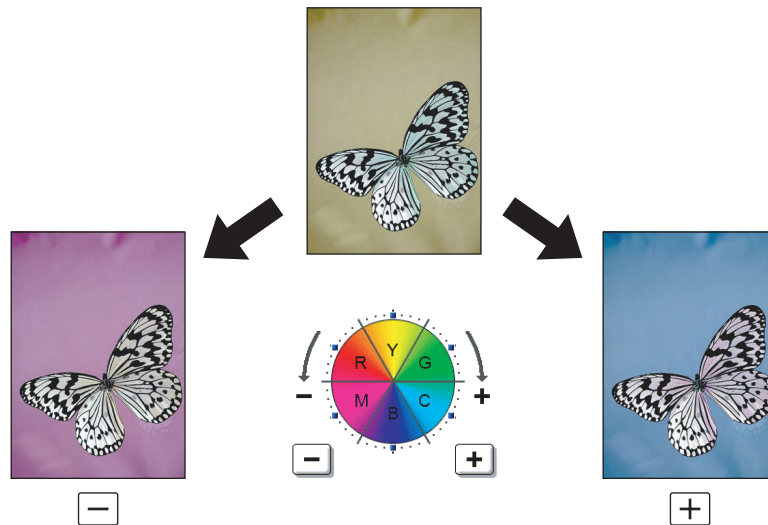

1 Press [HUE] in the IMAGE menu.

2 Adjust the hue.

- 1) Adjust the hue of the entire image by pressing **-** or **+**, in section A.
- 2) Adjust the hue of each basic color by pressing **-** or **+**, in section B.
- 3) Press [OK].

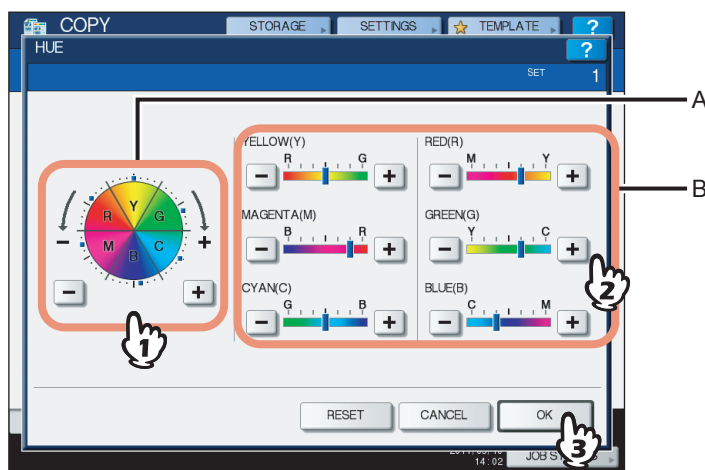

Canceling hue adjustment

- Move the indicator of the color whose adjustment you want to cancel to the middle, and then press [OK].
- If you want to cancel the adjustment of all colors, press [RESET], and then [OK].

■ Saturation

This function enables you to adjust the color saturation of the entire image. This function is available in the full color mode or the auto color mode.

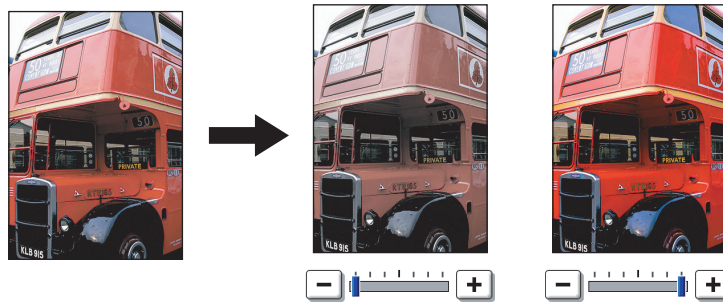

1 Press [SATURATION] in the IMAGE menu.

2 Press **[-]** or **[+]** to adjust the saturation, and then press [OK].

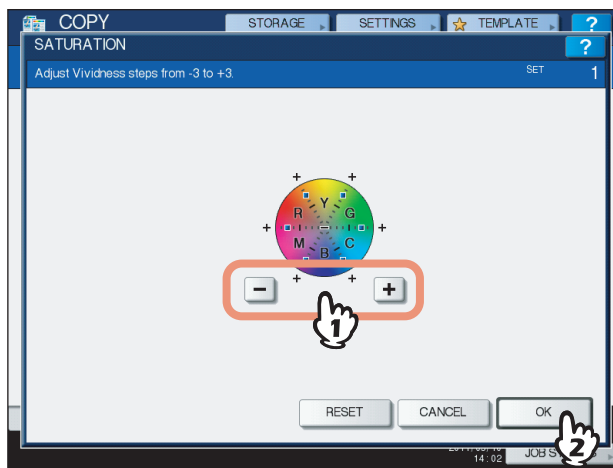

Canceling saturation adjustment

- Move the indicator to the middle, and then press [OK].
- Press [RESET], and then [OK].

■ ADF Scan Noise Reduction

You can set the scan noise reduction level for scanning originals with the Reversing Automatic Document Feeder at copying. Scan noise can be reduced if it is conspicuous on images due to fine dust.

- 1 Press [ADF NOISE REDUCTION] in the IMAGE menu.
- 2 Press [LOW], [MIDDLE], or [HIGH] to adjust the scan noise reduction level, and then press [OK].

Tip

Fine lines other than scan noise may become faint if you set the scan noise reduction level higher.

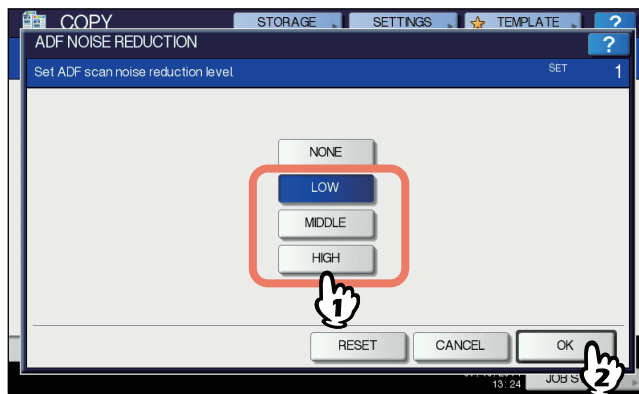

Canceling the ADF scan noise reduction

Press [NONE] or [RESET], and then [OK].

TEMPLATES

This chapter describes how to use templates.

Templates	146
Displaying template menu	146
Using “Useful Templates”	147
Registering Templates	149
Registering templates into the public template group	149
Creating a new private group	152
Registering templates into a private group	154
Recalling Templates	155
Changing Data	157
Changing private group data	157
Changing template data	158
Deleting Groups or Templates	160
Deleting private groups	160
Deleting templates	161

Templates

You can create a template with several functions that are frequently used so that they can be employed whenever you want by recalling the template, thus eliminating the need to perform complicated settings every time. Templates can be used in copying, scanning and sending a fax.

Note

Fax functions are available only when the FAX Unit (optional) is installed.

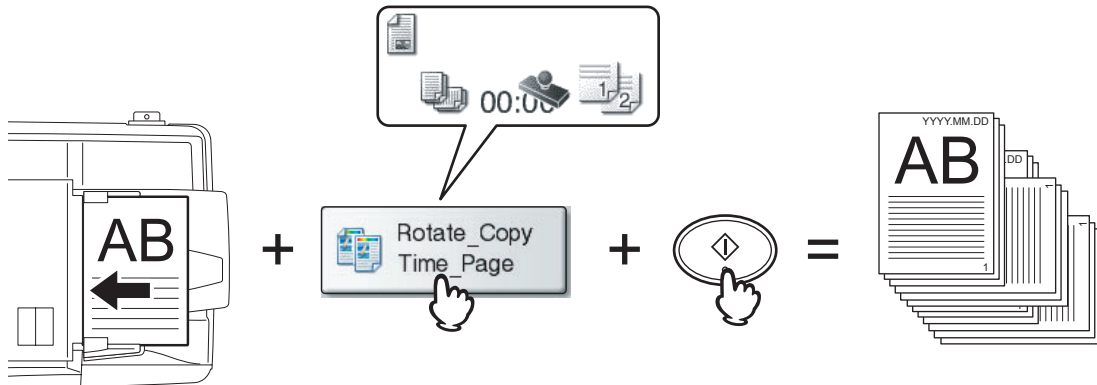

■ Displaying template menu

You can display the template menu by pressing [TEMPLATE] on the touch panel when you want to register or recall templates.

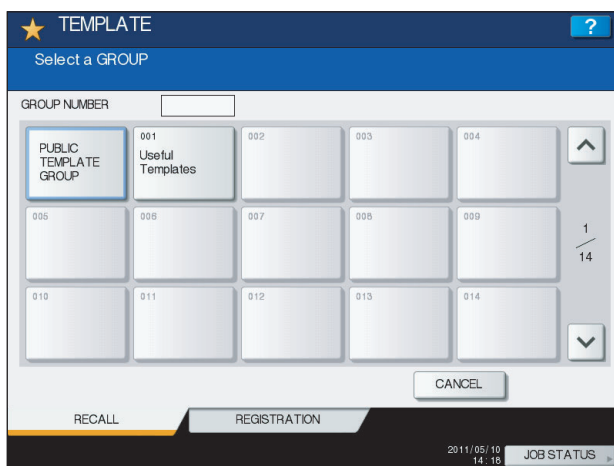

■ Using “Useful Templates”

This equipment has 12 default templates that can be used immediately. They are registered to the group number 001 “Useful Templates”. For how to recall them, see the following page:

📖 P.155 “Recalling Templates”



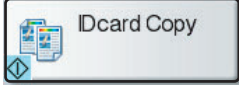
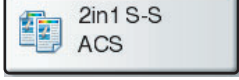
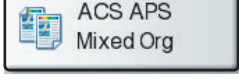
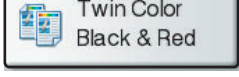

6

Templates with copying functions

Button	Function *1
 Icard Copy	Original size: 2-sided small originals, such as business cards Paper size: A4 (equipment for the A/B format), LT (equipment for the LT format) 2IN1 / 4IN1: 2IN1 (Place the original on the original glass before recalling the template since the automatic start is enabled in this template. After scanning the front side and then the back of the 2-sided original, press [JOB FINISH] to start copying.)
 2in1 S-S ACS	Color mode: AUTO COLOR 2IN1 / 4IN1: 2IN1 Simplex/Duplex: 1 -> 1 SIMPLEX
 ACS APS Mixed Org	Color mode: AUTO COLOR Paper selection: Automatic Paper Selection Original size: Mixed-size
 Twin Colour Black & Red	TWIN/MONO COLOR: TWIN COLOR (BLACK & RED)

Templates with scanning functions

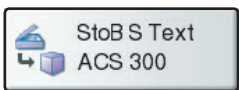
Button	Function *1
 StoF S Text Colour sPDF	Original: 1-sided Color mode: FULL COLOR Original mode: TEXT Storing method: Stored in the share folder of this equipment as a high-compression PDF file (multi)
 StoF D Text Colour sPDF	Original: 2-sided Color mode: FULL COLOR Original mode: TEXT Storing method: Stored in the share folder of this equipment as a high-compression PDF file (multi)
 StoF S T&P Bk 400 PDF	Original: 1-sided Color mode: BLACK Original mode: TEXT/PHOTO Resolution: 400 dpi Storing method: Stored in the share folder of this equipment as a PDF file (multi)
 StoB S Text ACS 300	Original: 1-sided Color mode: AUTO COLOR Original mode: TEXT Resolution: 300 dpi Storing method: Stored in the e-Filing box (public box)

Templates with e-Filing functions

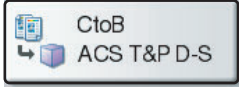
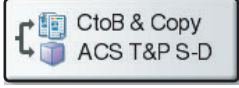
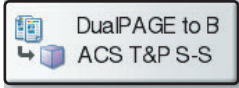
Button	Function *1
 <p>CtoB ACS T&P S-S</p>	<p>Color mode: AUTO COLOR Original mode: TEXT/PHOTO Simplex/Duplex: 1 -> 1 SIMPLEX Storing method: Stored in the e-Filing box No copying</p>
 <p>CtoB ACS T&P D-S</p>	<p>Color mode: AUTO COLOR Original mode: TEXT/PHOTO Simplex/Duplex: 2 -> 1 SPLIT Storing method: Stored in the e-Filing box No copying</p>
 <p>CtoB & Copy ACS T&P S-D</p>	<p>Color mode: AUTO COLOR Original mode: TEXT/PHOTO Simplex/Duplex: 1 -> 2 DUPLEX Storing method: Stored in the e-Filing box Copying performed</p>
 <p>DualPAGE to B ACS T&P S-S</p>	<p>Color mode: AUTO COLOR Original mode: TEXT/PHOTO Simplex/Duplex: 1 -> 1 SIMPLEX Editing function: Dual page Storing method: Stored in the e-Filing box (public box) No copying (The dual page function is available only for A4, LT and B5 sizes.)</p>

*1 Functions other than those noted here are in their default settings.

Registering Templates

Templates must be registered to either the “public template group” or “private groups”. You can set a password to restrict the use of registered templates.

Public template group:

Provided by default. Templates in this group can be used by everyone. It is useful to register several combinations of functions frequently used in the entire office or department. Up to 64 templates can be registered to the public group. The Admin (administrator) Password is required when you wish to register, delete or change templates in the public template group.

Private group:

You can create up to 200 private groups. These are useful for each department, section or user. Up to 64 templates can be registered per group. You can set a password to restrict the use of the registered templates. “Useful Templates” are registered under the group 001 by default.

■ Registering templates into the public template group

1 Set all the required functions.

Example: Editing function – image shift, reproduction ratio – 90%, number of copy sets – 10

2 Press [TEMPLATE] on the touch panel.

The template menu appears.

3 Select the public template group.

- 1) Press the [REGISTRATION] tab.
- 2) Press [PUBLIC TEMPLATE GROUP].
- 3) Press [OPEN].

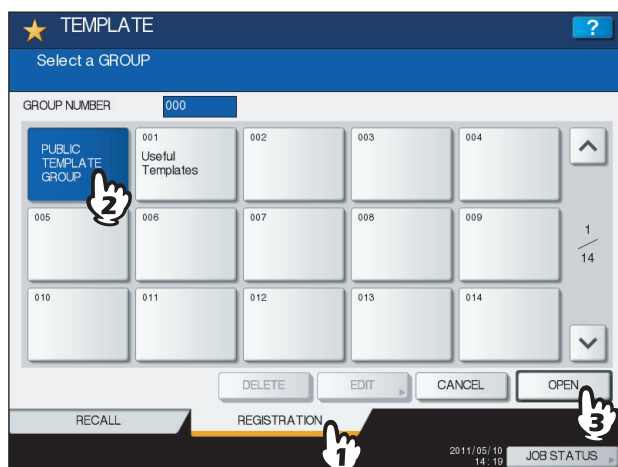

4 Press [PASSWORD].

The on-screen keyboard appears.

5 Enter the Admin Password using the on-screen keyboard or the digital keys. Then press [OK].

6 Select a template.

- 1) Press a blank button.
- 2) Press [SAVE].

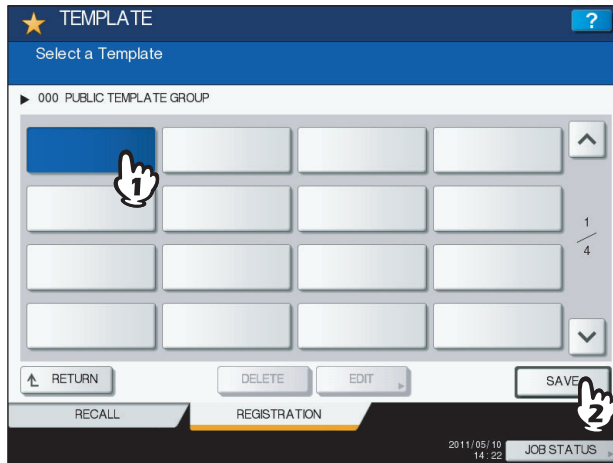

To switch the menu

Press or .

7 Enter the necessary information about the template.

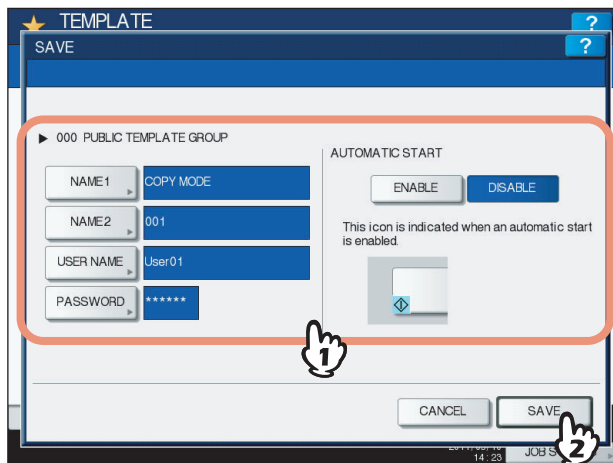

NAME 1 & 2: Enter the name of the template. NAME 1 appears above the template button and NAME 2 appears below. Be sure to enter at least one of them. When you press either of them, the on-screen keyboard appears. Enter within 11 characters.

Note

The symbols below cannot be used.

; : / \ " = | * < > ? + [] , .

USER NAME: Enter the name of the template owner as required. When you press it, the on-screen keyboard appears. Enter within 30 characters.

PASSWORD: Key in a password here, if you want to require a password to recall the template. When you press it, the on-screen keyboard appears. Key in following the procedure below.

- 1) Press [PASSWORD] and then enter the password (up to 20 characters) with the buttons on the touch panel or the digital keys on the control panel. The characters keyed in appear as asterisks (*).
- 2) Press [RETYPE PASSWORD], and then key in the password again.
- 3) Press [OK].

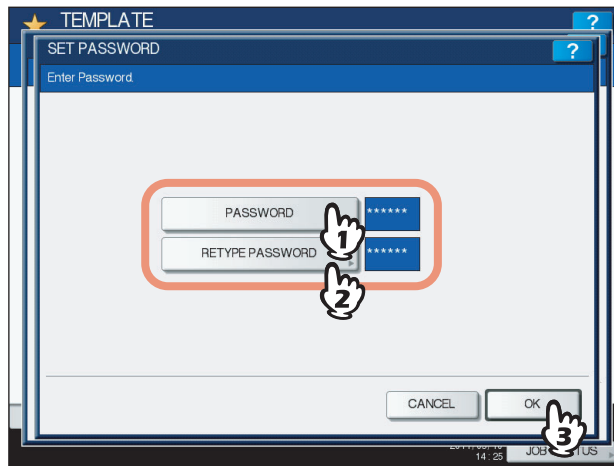

Note

The symbols below cannot be used.
' \ % & < > []

AUTOMATIC START: Press [ENABLE] if you want the operation of set functions to start immediately after pressing a button for the corresponding template. Press [DISABLE] if you do not want it to start until you press the [START] button on the control panel.

Note

Even when the automatic start function is enabled, you need to enter the user name and password when recalling the template in the following cases. For details of the User Authentication for Scan to E-mail and the user management function, ask your administrator.

- When the User Authentication for Scan to E-mail is enabled and the user management function is disabled
- When both the User Authentication for Scan to E-mail and the user management function are enabled, but the user names and passwords are different

When you have entered all the necessary items, press [SAVE].

The template is now registered and the menu returns to the one immediately before registration.

■ Creating a new private group

- 1 Press [TEMPLATE] on the touch panel.
The template menu appears.

- 2 Select a group.

- 1) Press the [REGISTRATION] tab.
- 2) Select the desired group by pressing its button or keying in its group number (3 digits).
- 3) Press [OPEN].

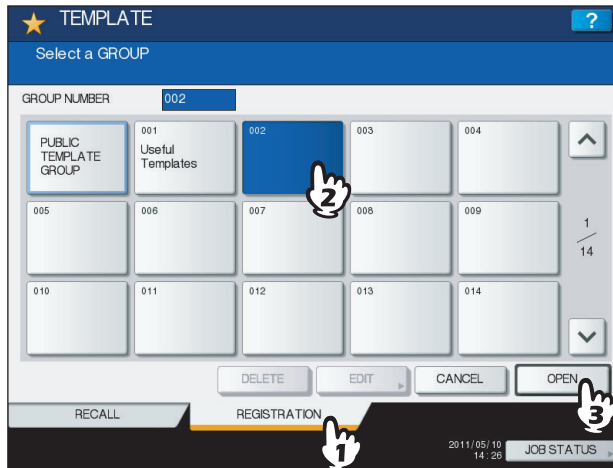

To switch the menu

Press or .

- 3 Enter the necessary information about the group.

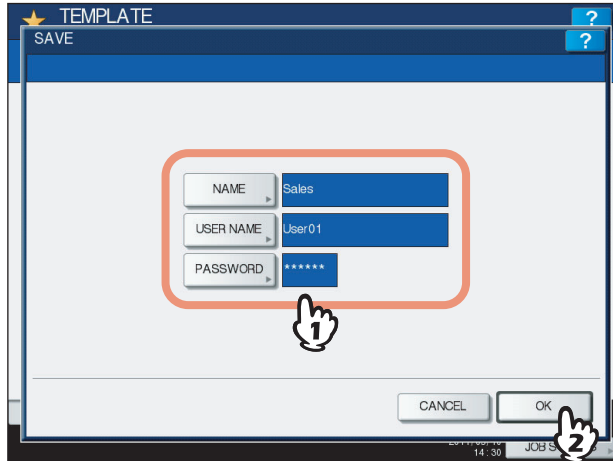

NAME: Enter the name of the group. When you press it, the on-screen keyboard appears. Enter within 20 characters. Be sure to enter it.

USER NAME: Enter the name of the group owner as required. When you press it, the on-screen keyboard appears. Enter within 30 characters.

PASSWORD: Key in a password here, if you want to require a password to view the group or register templates into the group. When you press it, the on-screen keyboard appears. Key in following the procedure below.

- 1) Press [PASSWORD] and then enter the password (up to 20 characters) with the buttons on the touch panel or the digital keys on the control panel. The characters keyed in appear as asterisks (*).
- 2) Press [RETYPE PASSWORD], and then key in the password again.
- 3) Press [OK].

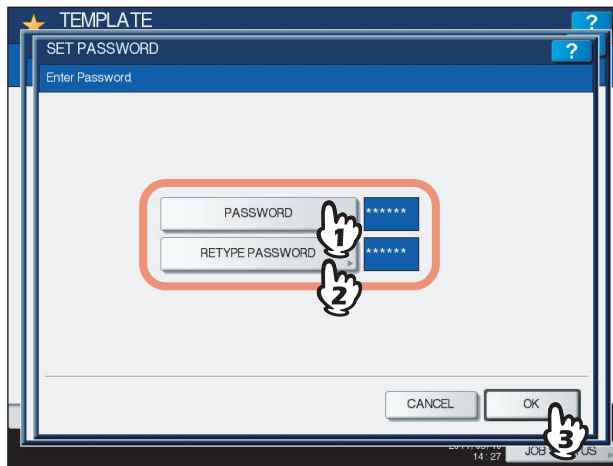

Note

The symbols below cannot be used.
' \ % & < > []

When you have entered all the necessary items, press [OK].
The new group is now registered and the menu moves to the one for registering templates.

- 4** Press the [FUNCTION CLEAR] button on the control panel.
The menu returns to the BASIC menu.

■ Registering templates into a private group

1 Set all the required functions.

Example: Editing function – image shift, reproduction ratio – 90%, number of copy sets – 10

Note

The [PAPER SIZE] and [PAPER TYPE] functions for bypass copying cannot be set in templates.

2 Press [TEMPLATE] on the touch panel.

The template menu appears.

3 Select the desired group.

- 1) Press the [REGISTRATION] tab.
- 2) Select the desired group by pressing its button or keying in its group number (3 digits).
- 3) Press [OPEN].

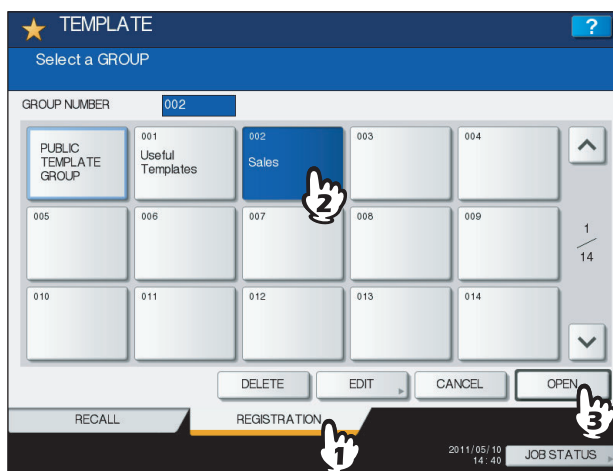

To switch the menu

Press or .

4 Key in the password for the selected group. (If no password is set, go to step 5.)

- 1) Press [PASSWORD] and then enter the password with the buttons on the touch panel or the digital keys on the control panel.
- 2) Press [OK].

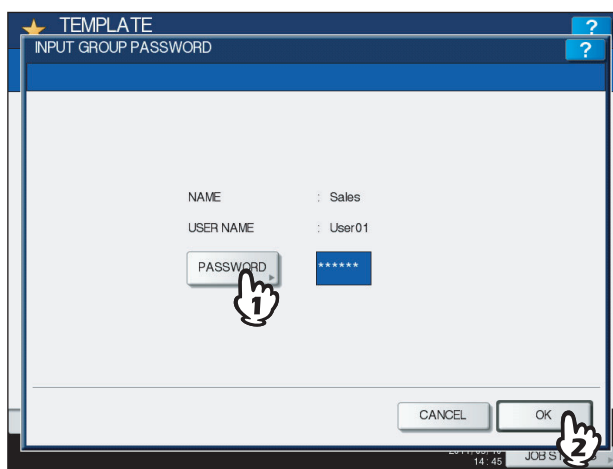

5 Register a template following steps 6 and 7 on [P.149](#) “Registering templates into the public template group”.

Recalling Templates

When you recall a template, the functions set in the template will be available automatically. If the automatic start function is enabled, this equipment will automatically start the operation of each function when you press the button for the corresponding template.

- 1 Place paper in the drawer(s).**
- 2 Place the original(s).**
- 3 Press [TEMPLATE] on the touch panel.**
The template menu appears.
- 4 Press the button for the group to which the desired template is registered.**
You can also select the group by keying in its group number (3 digits).

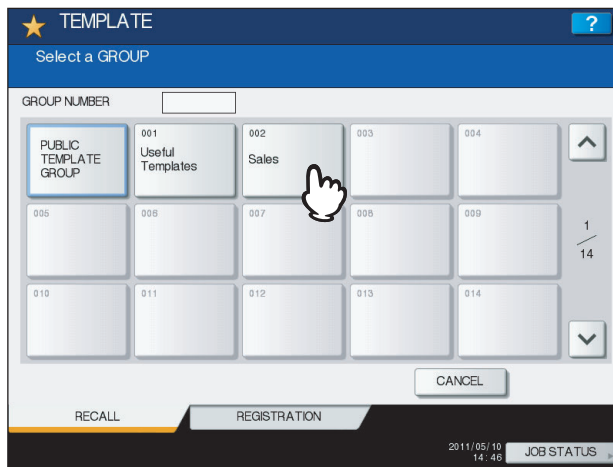

To switch the menu

Press or .

- 5 Key in the password when you have selected the private group. (If no password is set, go to step 6.)**
 - 1) Press [PASSWORD] and then enter the password with the buttons on the touch panel or the digital keys on the control panel.
 - 2) Press [OK].

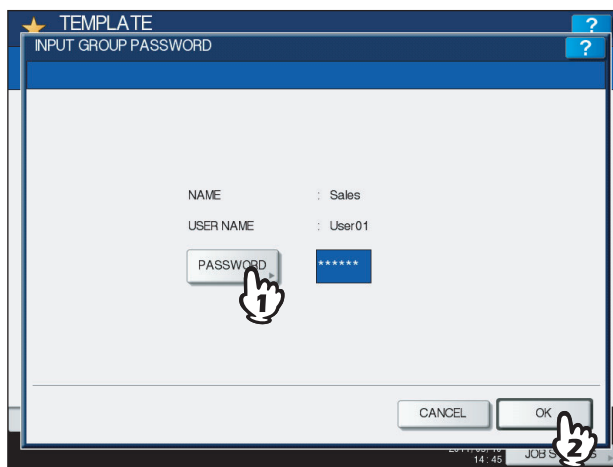

6 Press the button for the desired template.

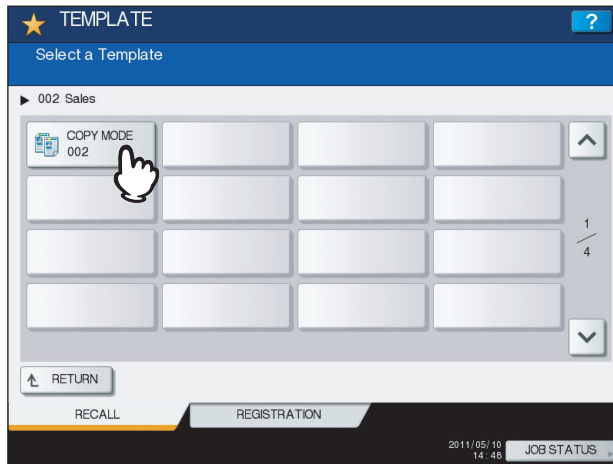

To switch the menu

Press or .

Templates with the automatic start function enabled can be identified with . If this mark is displayed, you can press it to immediately start the operation of the functions set in the template.

7 Key in the password for the selected template. (If no password is set, go to step 8.)

- 1) Press [PASSWORD] and then enter the password with the buttons on the touch panel or the digital keys on the control panel.
- 2) Press [OK].

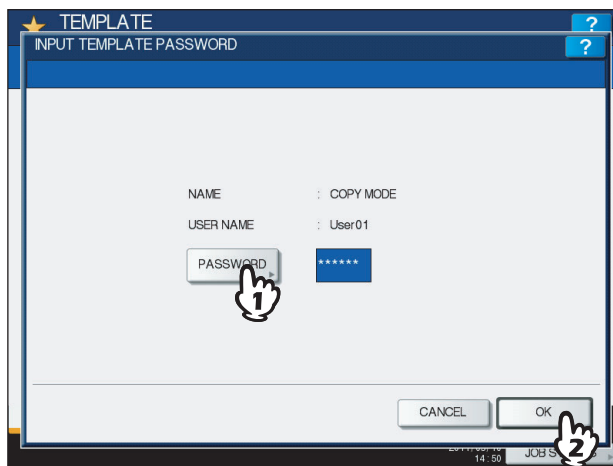

8 Confirm that “Updated the template setting” is displayed on the touch panel.

The message is displayed for approx. 3 seconds.

9 Select other copy modes as required, and then press the [START] button on the control panel.

Changing Data

You can change the data of templates or private groups that are already registered, such as the template name, user name, password and setting of the automatic start function.

Note

The data of the public template group can be changed from the TopAccess menu but this cannot be done from the control panel. For how to change them from the TopAccess menu, refer to the **TopAccess Guide**.

■ Changing private group data

1 In the template menu, select the desired group.

- 1) Press the [REGISTRATION] tab.
- 2) Select the desired group by pressing its button or keying in its group number (3 digits).
- 3) Press [EDIT].

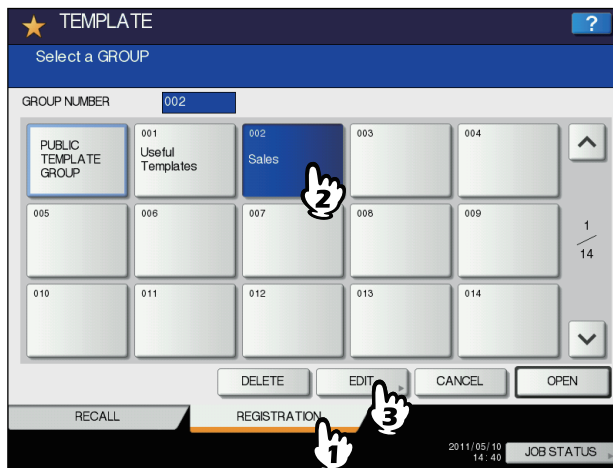

To switch the menu

Press or .

2 Key in the password for the selected group. (If no password is set, go to step 3.)

- 1) Press [PASSWORD] and then enter the password with the buttons on the touch panel or the digital keys on the control panel.
- 2) Press [OK].

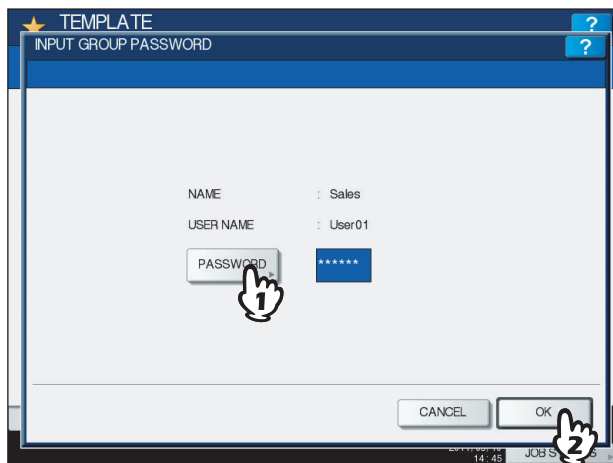

3 Change the data following step 3 on [P.152](#) “Creating a new private group”.

4 Press the [FUNCTION CLEAR] button on the control panel.

The menu returns to the BASIC menu.

■ Changing template data

1 In the template menu, select the group to which the desired template is registered.

- 1) Press the [REGISTRATION] tab.
- 2) Select the desired group by pressing its button or keying in its group number (3 digits).
- 3) Press [OPEN].

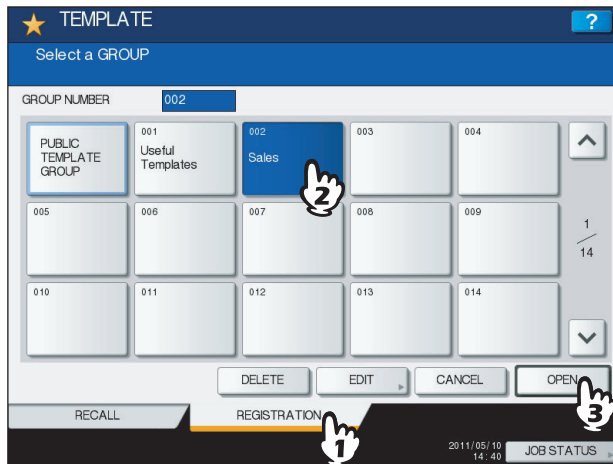

To switch the menu

Press or .

2 Enter the password as follows and then press [OK].

When the public template group is selected: Press [PASSWORD] and then enter the Admin Password (6 to 64 characters) with the buttons on the touch panel or the digital keys on the control panel.

When a private group is selected: Press [PASSWORD] and then enter the password (up to 20 characters) with the buttons on the touch panel or the digital keys on the control panel. If no password is set, go to step 3.

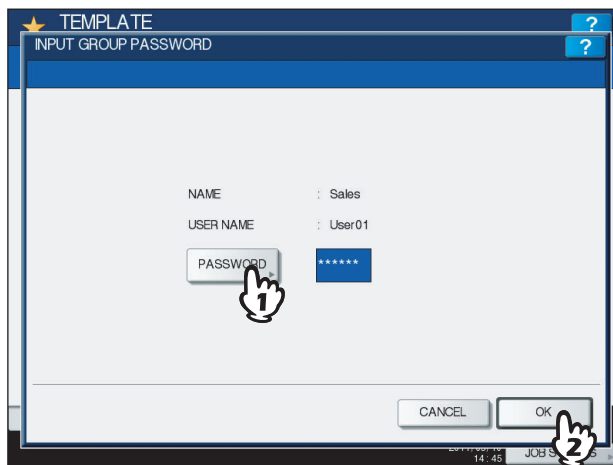

3 Select the desired template.

- 1) Press the button for the corresponding template.
- 2) Press [EDIT].

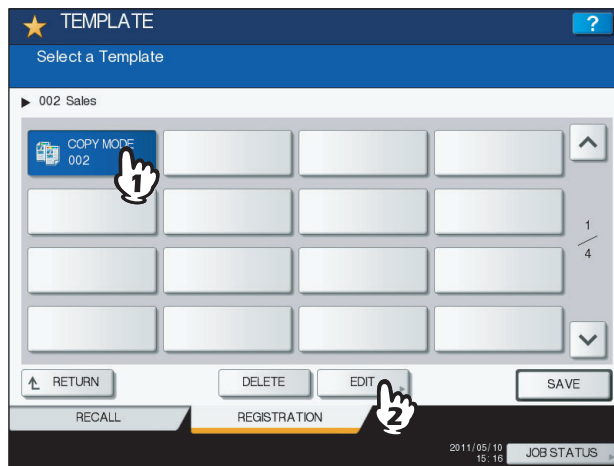

To switch the menu

Press or .

4 Key in the password for the selected template. (If no password is set, go to step 5.)

- 1) Press [PASSWORD] and then enter the password with the buttons on the touch panel or the digital keys on the control panel.
- 2) Press [OK].

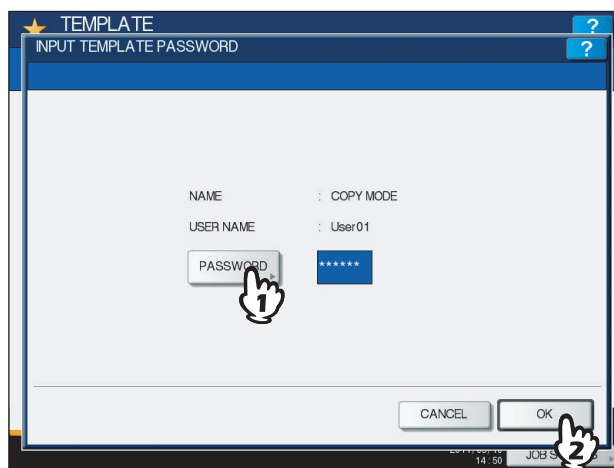

5 Change the data following step 7 on [P.149](#) “Registering templates into the public template group”.

Deleting Groups or Templates

You can delete private groups or templates no longer needed. If a private group is deleted, all the templates in the private group are also deleted.

Note

The public template group cannot be deleted.

■ Deleting private groups

1 In the template menu, select the desired private group.

- 1) Press the [REGISTRATION] tab.
- 2) Select the desired group by pressing its button or keying in its group number (3 digits).
- 3) Press [DELETE].

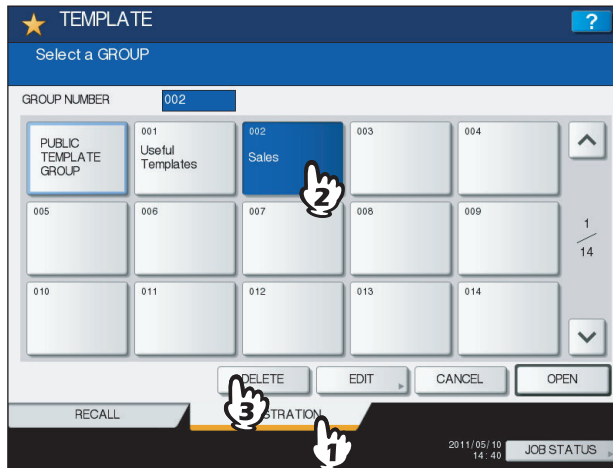

To switch the menu

Press or .

2 Key in the password for the selected group. (If no password is set, go to step 3.)

- 1) Press [PASSWORD] and then enter the password with the buttons on the touch panel or the digital keys on the control panel.
- 2) Press [OK].

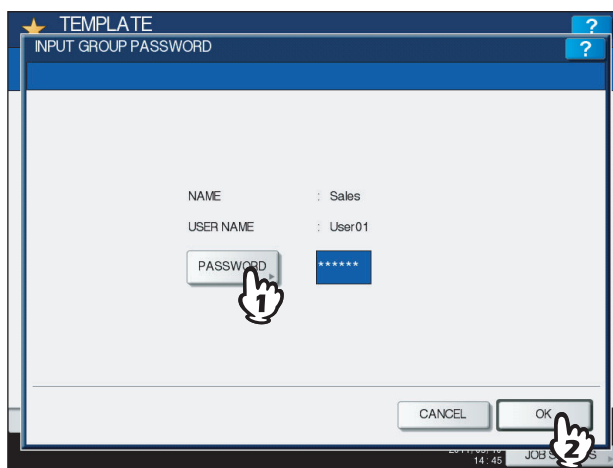

3 Press [DELETE].

The private group is now deleted.

■ Deleting templates

1 In the template menu, select the group to which the desired template is registered.

- 1) Press the [REGISTRATION] tab.
- 2) Select the desired group by pressing its button or keying in its group number (3 digits).
- 3) Press [OPEN].

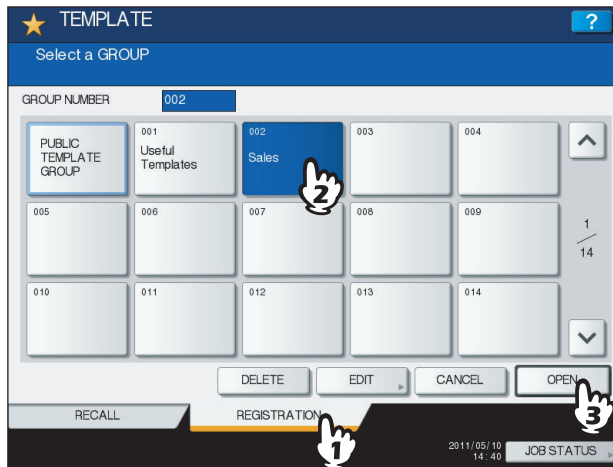

To switch the menu

Press or .

2 Enter the password as follows and then press [OK].

When the public template group is selected: Press [PASSWORD] and then enter the Admin Password (6 to 64 characters) with the buttons on the touch panel or the digital keys on the control panel.

When a private group is selected: Press [PASSWORD] and then enter the password (up to 20 characters) with the buttons on the touch panel or the digital keys on the control panel. If no password is set, go to step 3.

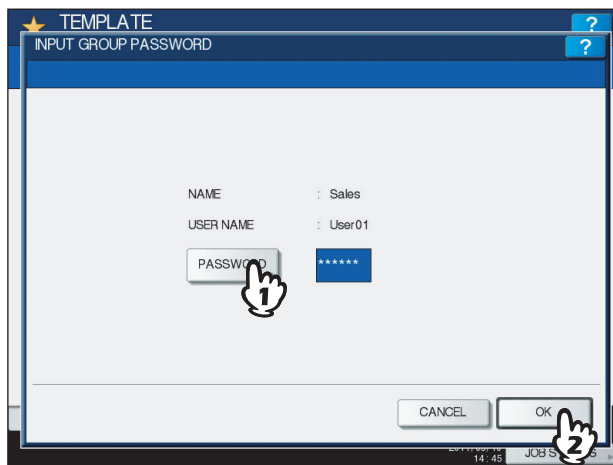

3 Select the desired template.

- 1) Press the button for the desired template.
- 2) Press [DELETE].

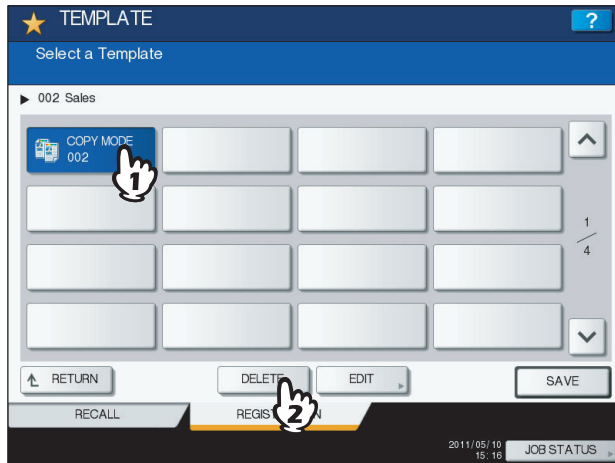

To switch the menu

Press or .

4 Key in the password for the selected template. (If no password is set, go to step 5.)

- 1) Press [PASSWORD] and then enter the password with the buttons on the touch panel or the digital keys on the control panel.
- 2) Press [OK].

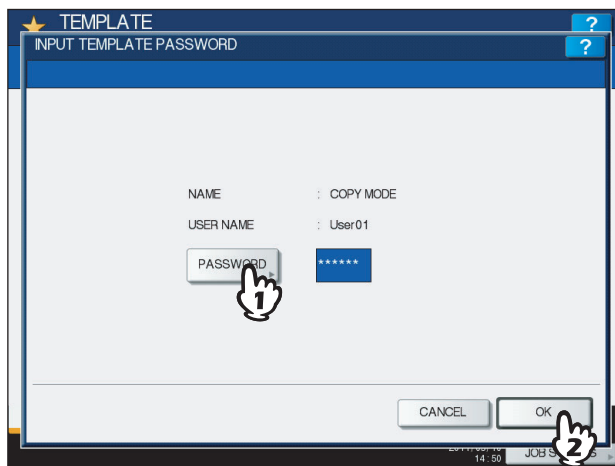

5 Press [DELETE].

The template is now deleted.

CONFIRMING JOB STATUS

This chapter describes how to confirm the processing status and the history of copy jobs performed, and the amount of toner remaining in the toner cartridges.

Confirming Copy Job Status	164
Confirming jobs in progress or ones in waiting	164
Confirming copy job history	169
Confirming drawers	170
Confirming amount of toner remaining	171

Confirming Copy Job Status

You can confirm jobs in progress or ones in waiting, on the touch panel. Also you can delete, pause or resume jobs in waiting, and change their order. You can also confirm the history of copy jobs performed, the status of drawers and the amount of toner remaining in the toner cartridges.

Note

When this equipment is managed with the user management function, copy jobs in waiting only for a user who has logged in can be deleted, paused or their order changed, and the job history only for such a user is displayed on the print log list.

However, if the user has an administrator privilege, all copy jobs in waiting can be deleted, paused or their order changed, and the entire job history is displayed on the print log list.

Confirming jobs in progress or ones in waiting

You can confirm the jobs in progress or the ones in waiting, on the touch panel. To view them, press [JOB STATUS] on the touch panel.



The print job list appears. (Press the [JOBS] tab if another tab menu is displayed.) Copy jobs appear on the print job list as well as print jobs.

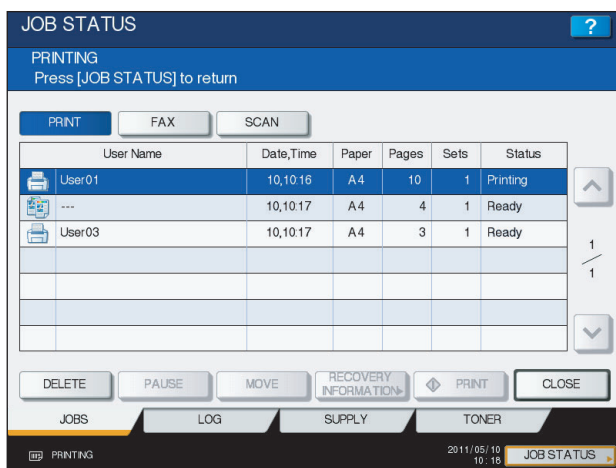

On the print job list, you can confirm the icon of the job type, the name of the user who sent the job, the date and time the job was sent, the paper size, the number of pages and copy sets and the processing status. 7 jobs appear on 1 page of the print job list. When you press or on the touch panel, the menu will be changed to the previous one or the next one, so that you can view up to 1000 jobs.

Press [CLOSE] when you finish the confirmation. The menu returns to the one shown before you pressed [JOB STATUS].

□ Deleting jobs

You can delete jobs that you no longer need to print.

- 1 Select the desired job on the print job list, and then press [DELETE]. You can select more than one job.

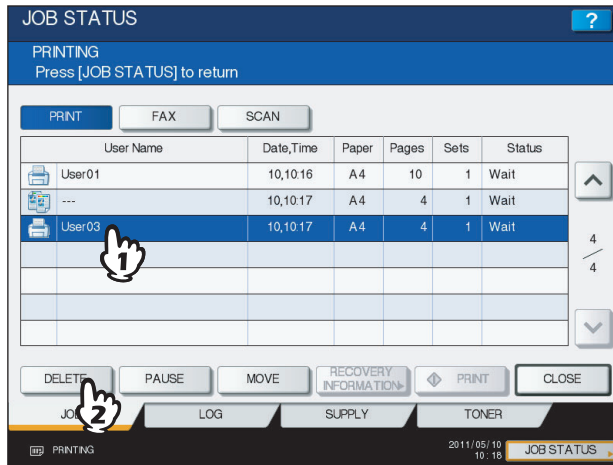

- 2 Press [DELETE].
The job is now deleted.

Tip

You cannot use the print job list to delete fax/Internet Fax jobs and E-mail reception print jobs.

□ Pausing jobs

Jobs whose status is "Wait" can be held in the queue (Pausing).
Select the desired job on the print job list, and then press [PAUSE].

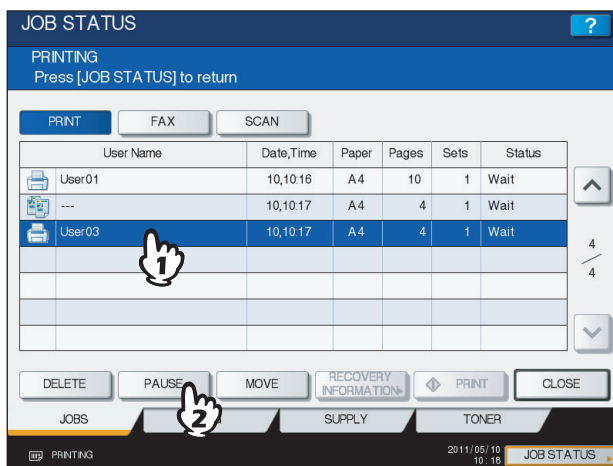

The job is now paused. The paused job is not printed even when its turn comes. Printing of the next job starts.

Resuming the paused job

Select the desired job, and then press [RESUME].

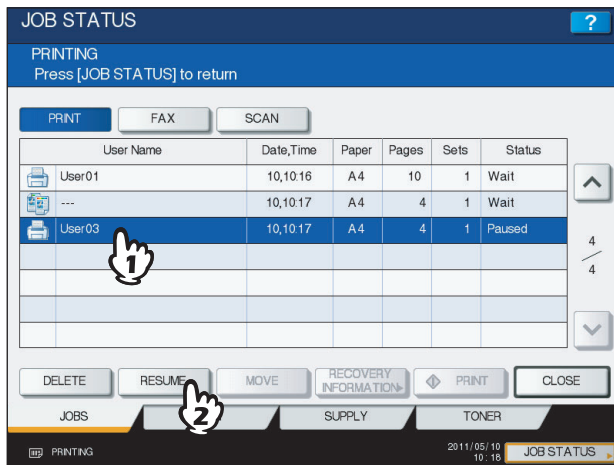

□ Moving jobs

You can change the order of the jobs in waiting by moving them within the list.

Note

You can only move jobs from and to those whose status is "Wait".

- 1 Select the desired job on the print job list, and then press [MOVE].

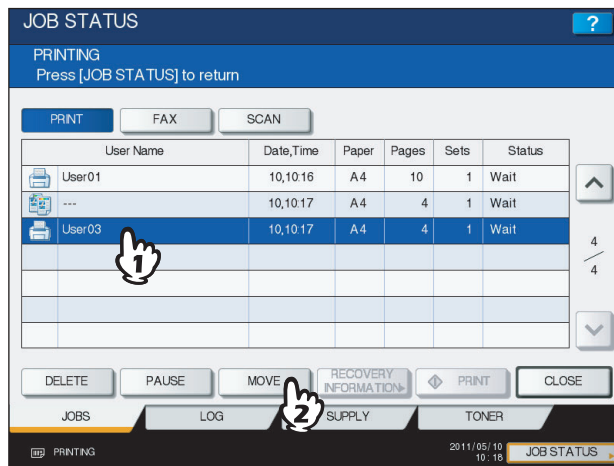

2 Select the position that you want the job to move to. (It will come under the selected job.)

JOB STATUS ?

Select the destination you want to move

PRINT FAX SCAN

User Name	Date,Time	Paper	Pages	Sets	Status
User01	10,10,16	A4	10	1	Wait
---	10,10,17	A4	4	1	Wait
User03	10,10,17	A4	4	1	Wait

4 / 4

DELETE PAUSE MOVE RECOVERY INFORMATION PRINT CLOSE

JOB LOG SUPPLY TONER

PRINTING 2011/05/10 10:18 JOB STATUS



JOB STATUS ?

PRINTING
Press [JOB STATUS] to return

PRINT FAX SCAN

User Name	Date,Time	Paper	Pages	Sets	Status
User01	10,10,16	A4	10	1	Wait
User03	10,10,17	A4	4	1	Wait
---	10,10,17	A4	4	1	wait

4 / 4

DELETE PAUSE MOVE RECOVERY INFORMATION PRINT CLOSE

JOB LOG SUPPLY TONER

PRINTING 2011/05/10 10:18 JOB STATUS

□ Confirming the information of a skipped job

Copy jobs may not be performed because the specified paper or staples have run out, etc. These will be suspended and the next job will be performed (Job Skip function). Check on the touch panel how you can recover the suspended jobs.

1 Select the skipped job in the print job list, and press [RECOVERY INFORMATION].

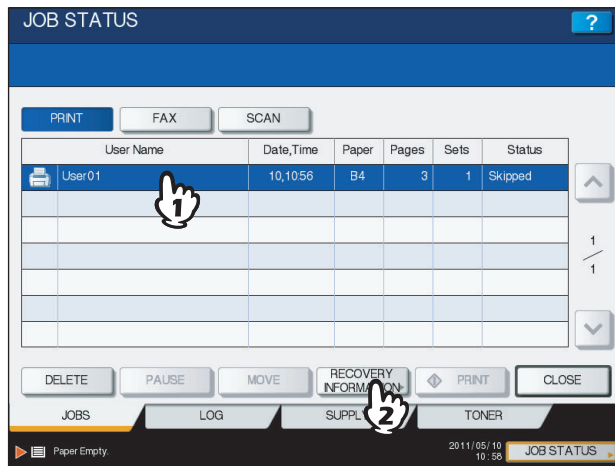

2 Resolve the cause of the skip following the instructions on the screen.

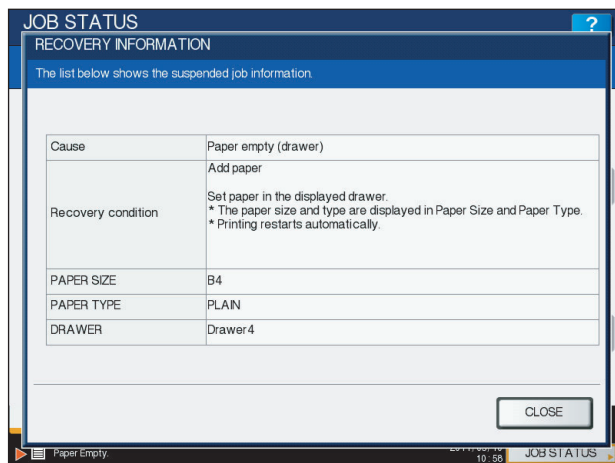

Note

If multiple causes exist, the second cause is displayed after you resolve the first one. Resolve all causes accordingly.

■ Confirming copy job history

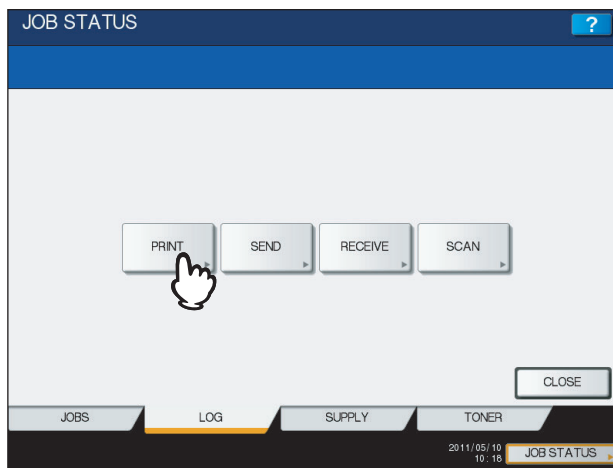

You can confirm the history of copy jobs performed on the touch panel.

- 1 Press [JOB STATUS] on the touch panel.
- 2 Press the [LOG] tab.
- 3 Press [PRINT].

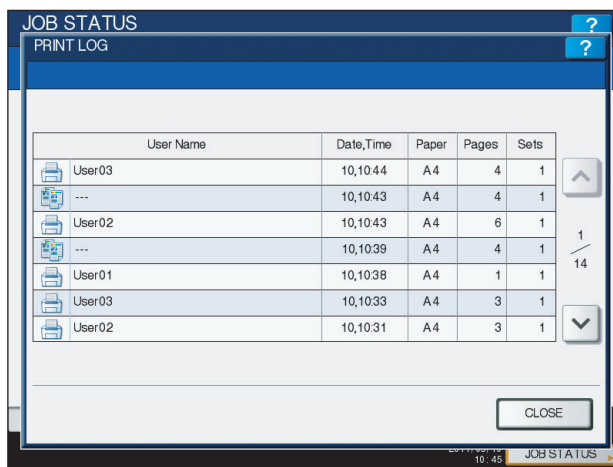

The print log list appears. Copy jobs appear on the print log list as well as print jobs.



On the print log list, you can confirm the icon of the job type, the name of the user who performed the job, the date and time the job was printed, the paper size and the number of pages or copy sets. 7 jobs appear on 1 page of the print log list. When you press  or  on the touch panel, the menu will be changed to the previous one or the next one, so that you can view up to 120 jobs.

When you finish the confirmation, press [CLOSE] so that the menu returns to the one in step 3, and then press [CLOSE]. The menu returns to the one shown before you pressed [JOB STATUS].

■ Confirming drawers

You can confirm the size and type-setting of the paper or the amount remaining in the drawers. During printing you can confirm which drawer is feeding paper.

1 Press [JOB STATUS] on the touch panel.

2 Press the [SUPPLY] tab.

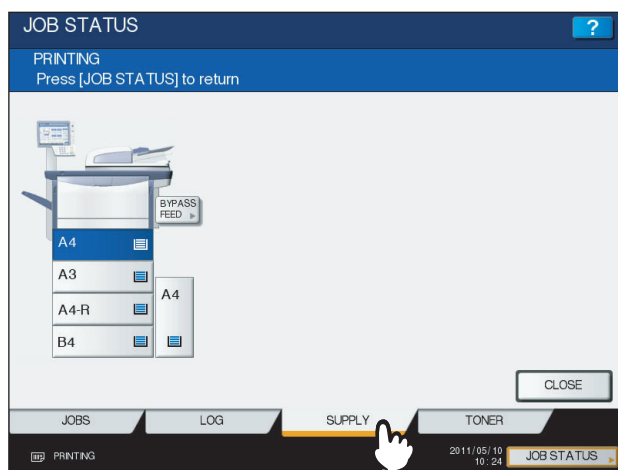

During printing, the button for the drawer from which the paper is fed is highlighted.

Press [CLOSE] when you finish the confirmation. The menu returns to the one shown before you pressed [JOB STATUS].

When the paper in the drawer has run out during printing, [JOB STATUS] on the touch panel blinks. In this case, press [JOB STATUS] so that the menu for displaying the printing status will appear and the button for the drawer whose paper has run out will blink on this menu. Printing resumes when you add paper to this drawer.

📖 P.11 "Placing Paper"

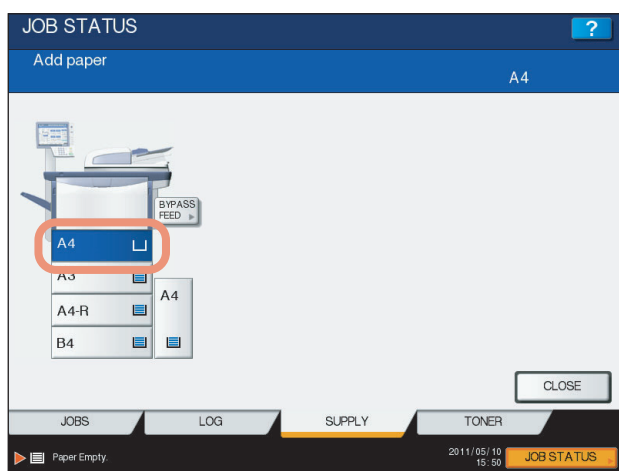

■ Confirming amount of toner remaining

You can confirm the approximate amount of toner remaining in the toner cartridge.

1 Press [JOB STATUS] on the touch panel.

2 Press the [TONER] tab.

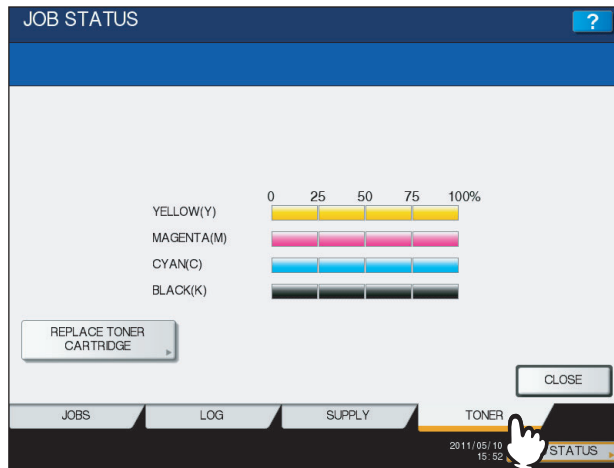

Press [CLOSE] when you finish the confirmation. The menu returns to the one shown before you pressed [JOB STATUS].

OTHER INFORMATION

Continuous Copying Speed	174
Color copying	174
Black-and-white copying	175
Copying Function Combination Matrix	177
Combination matrix 1/2	177
Combination matrix 2/2	178
Image Adjustment Function Combination Matrix	179
Combination matrix 1/2	179
Combination matrix 2/2	180

Continuous Copying Speed

Copy speeds under the condition in which originals are placed on the original glass and single-side copies are made continuously with 100% reproduction ratio in the non-sort mode (unit: sheet/minute).

Tips

- Color copying consists of FULL COLOR, TWIN COLOR, MONO COLOR and IMAGE SMOOTHING.
- TOSHIBA-recommended paper is used for the values of the specifications below.
- The bypass copying speed when the paper size is specified is as listed below.
- These specifications vary depending on the copying conditions and the environment.

■ Color copying

e-STUDIO5560C

Paper size	Feeder	Paper type						
		PLAIN/ RECYCLED PAPER	THICK1	THICK2	THICK3	THICK4	SPECIAL 1	SPECIAL 2
A4, A5-R, B5, LT, ST-R, 8.5"SQ	Drawer	55	32	32	21	—	—	—
	Bypass tray	46	26	26	17	17	6	17
A4-R, B5-R, LT-R	Drawer	38	23	23	15	—	—	—
	Bypass tray	35	20	20	13	13	4.5	13
B4, FOLIO, LG, COMP, 13"LG	Drawer	29	15.5	15.5	10.5	—	—	—
	Bypass tray	27	13	13	9.5	9.5	3	9.5
A3, LD	Drawer	27	13.5	13.5	9	—	—	—
	Bypass tray	24	11	11	8	8	2.5	8
305 mm x 457 mm, 320 mm x 450 mm, 320 mm x 460 mm, 330 mm x 483 mm *1	Drawer	25	12	12	8	—	—	—
	Bypass tray	20	9	9	6	6	2	6

e-STUDIO6560C

Paper size	Feeder	Paper type						
		PLAIN/ RECYCLED PAPER	THICK1	THICK2	THICK3	THICK4	SPECIAL 1	SPECIAL 2
A4, A5-R, B5, LT, ST-R, 8.5"SQ	Drawer	65	32	32	21	—	—	—
	Bypass tray	48	26	26	17	17	6	17
A4-R, B5-R, LT-R	Drawer	46	23	23	15	—	—	—
	Bypass tray	36	20	20	13	13	4.5	13
B4, FOLIO, LG, COMP, 13"LG	Drawer	31	15.5	15.5	10.5	—	—	—
	Bypass tray	28	13	13	9.5	9.5	3	9.5
A3, LD	Drawer	30	13.5	13.5	9	—	—	—
	Bypass tray	25	11	11	8	8	2.5	8
305 mm x 457 mm, 320 mm x 450 mm, 320 mm x 460 mm, 330 mm x 483 mm *1	Drawer	27	12	12	8	—	—	—
	Bypass tray	21	9	9	6	6	2	6

e-STUDIO6570C

Paper size	Feeder	Paper type						
		PLAIN/ RECYCLED PAPER	THICK1	THICK2	THICK3	THICK4	SPECIAL 1	SPECIAL 2
A4, A5-R, B5, LT, ST-R, 8.5"SQ	Drawer	65	32	32	21	—	—	—
	Bypass tray	48	26	26	17	17	6	17
A4-R, B5-R, LT-R	Drawer	46	23	23	15	—	—	—
	Bypass tray	36	20	20	13	13	4.5	13
B4, FOLIO, LG, COMP, 13"LG	Drawer	31	15.5	15.5	10.5	—	—	—
	Bypass tray	28	13	13	9.5	9.5	3	9.5
A3, LD	Drawer	30	13.5	13.5	9	—	—	—
	Bypass tray	25	11	11	8	8	2.5	8
305 mm x 457 mm, 320 mm x 450 mm, 320 mm x 460 mm, 330 mm x 483 mm *1	Drawer	31	12	12	8	—	—	—
	Bypass tray	21	9	9	6	6	2	6

*1 330 mm x 483 mm sized paper can be set on the bypass tray only.

■ Black-and-white copying

e-STUDIO5560C

Paper size	Feeder	Paper type						
		PLAIN/ RECYCLED PAPER	THICK1	THICK2	THICK3	THICK4	SPECIAL 1	SPECIAL 2
A4, A5-R, B5, LT, ST-R, 8.5"SQ	Drawer	55	32	32	32	—	—	—
	Bypass tray	46	26	26	26	26	6	17
A4-R, B5-R, LT-R	Drawer	38	23	23	23	—	—	—
	Bypass tray	35	20	20	20	20	4.5	13
B4, FOLIO, LG, COMP, 13"LG	Drawer	29	15.5	15.5	15.5	—	—	—
	Bypass tray	27	13	13	13	13	3	9.5
A3, LD	Drawer	27	13.5	13.5	13.5	—	—	—
	Bypass tray	24	11	11	11	11	2.5	8
305 mm x 457 mm, 320 mm x 450 mm, 320 mm x 460 mm, 330 mm x 483 mm *1	Drawer	25	12	12	12	—	—	—
	Bypass tray	20	9	9	9	9	2	6

e-STUDIO6560C

Paper size	Feeder	Paper type						
		PLAIN/ RECYCLED PAPER	THICK1	THICK2	THICK3	THICK4	SPECIAL 1	SPECIAL 2
A4, A5-R, B5, LT, ST-R, 8.5"SQ	Drawer	65	32	32	32	—	—	—
	Bypass tray	48	26	26	26	26	6	17
A4-R, B5-R, LT-R	Drawer	46	23	23	23	—	—	—
	Bypass tray	36	20	20	20	20	4.5	13
B4, FOLIO, LG, COMP, 13"LG	Drawer	31	15.5	15.5	15.5	—	—	—
	Bypass tray	28	13	13	13	13	3	9.5
A3, LD	Drawer	30	13.5	13.5	13.5	—	—	—
	Bypass tray	25	11	11	11	11	2.5	8
305 mm x 457 mm, 320 mm x 450 mm, 320 mm x 460 mm, 330 mm x 483 mm *1	Drawer	27	12	12	12	—	—	—
	Bypass tray	21	9	9	9	9	2	6

e-STUDIO6570C

Paper size	Feeder	Paper type						
		PLAIN/ RECYCLED PAPER	THICK1	THICK2	THICK3	THICK4	SPECIAL 1	SPECIAL 2
A4, A5-R, B5, LT, ST-R, 8.5"SQ	Drawer	75	32	32	32	—	—	—
	Bypass tray	52	26	26	26	26	6	17
A4-R, B5-R, LT-R	Drawer	54	23	23	23	—	—	—
	Bypass tray	38	20	20	20	20	4.5	13
B4, FOLIO, LG, COMP, 13"LG	Drawer	39	15.5	15.5	15.5	—	—	—
	Bypass tray	30	13	13	13	13	3	9.5
A3, LD	Drawer	37	13.5	13.5	13.5	—	—	—
	Bypass tray	27	11	11	11	11	2.5	8
305 mm x 457 mm, 320 mm x 450 mm, 320 mm x 460 mm, 330 mm x 483 mm *1	Drawer	31	12	12	12	—	—	—
	Bypass tray	23	9	9	9	9	2	6

*1 330 mm x 483 mm sized paper can be set on the bypass tray only.

Copying Function Combination Matrix

Combination matrix 1/2

	Store to e-File	Copy & File	Outside erase	Omit blank page	Image repeat	Full image	ADF->SADF	Book <-> TABLET	Image direction	Job build	Page number	Time stamp	Sheet insertion	Cover sheet				XY zoom		Edging
														Back - Only back copied	Back - Both copied	Back - Top/Back - Blank	Front - Both copied	Front - Top/Back - Blank	Front - Blank	
Bypass copy	*1	*1	Yes	Yes	*1	Yes	Yes	*1	Yes	*4	*1	*1	*3	*3	*3	*3	*3	Yes	*1	*1
Mixed original sizes	Yes	Yes	Yes	Yes	No	Yes	Yes	No	Yes	*4	No	No	No	No	No	No	No	No	No	No
Photo zoom	No	No	Yes	Yes	*3	Yes	Yes	No	No	*4	No	No	Yes	Yes	Yes	Yes	Yes	*3	Yes	Yes
1 - 1 Simplex	Yes	Yes	Yes	Yes	Yes	Yes	Yes	*3	Yes	Yes	Yes	Yes	Yes	Yes	Yes	Yes	Yes	Yes	Yes	Yes
1 - 2 Duplex	Yes	Yes	Yes	Yes	No	Yes	Yes	Yes	Yes	Yes	Yes	Yes	Yes	Yes	Yes	Yes	Yes	Yes	Yes	Yes
2 - 1 Split	Yes	Yes	Yes	Yes	Yes	Yes	Yes	*3	Yes	Yes	Yes	Yes	Yes	Yes	Yes	Yes	Yes	Yes	Yes	Yes
2 - 2 Duplex	Yes	Yes	Yes	Yes	No	Yes	Yes	Yes	Yes	Yes	Yes	Yes	Yes	Yes	Yes	Yes	Yes	Yes	Yes	Yes
Book - 2	Yes	Yes	Yes	No	No	No	-	No	Yes	No	Yes	Yes	No	No	No	No	No	No	No	No
Non-sort / Non-staple	*3	Yes	Yes	Yes	Yes	Yes	Yes	Yes	Yes	*4	Yes	Yes	*3	*3	*3	*3	*3	Yes	Yes	Yes
Sort	Yes	Yes	Yes	Yes	Yes	Yes	Yes	Yes	Yes	*4	Yes	Yes	Yes	Yes	Yes	Yes	Yes	Yes	Yes	Yes
Group	Yes	Yes	Yes	Yes	Yes	Yes	Yes	Yes	Yes	*4	Yes	Yes	No	No	No	No	No	Yes	Yes	Yes
Staple sort	Yes	Yes	Yes	Yes	Yes	Yes	Yes	Yes	Yes	*4	Yes	Yes	Yes	Yes	Yes	Yes	Yes	Yes	Yes	Yes
Magazine sort	No	No	Yes	Yes	No	No	Yes	No	Yes	Yes	Yes	Yes	No	No	No	No	No	Yes	Yes	Yes
Center fold	Yes	Yes	Yes	No	No	No	Yes	No	Yes	*4	No	No	No	No	No	No	No	Yes	Yes	No
Magazine sort & Saddle stitch	No	No	Yes	Yes	No	No	Yes	No	Yes	No	Yes	Yes	No	No	No	No	No	Yes	Yes	No
Magazine sort & Center fold	No	No	Yes	Yes	No	No	Yes	No	Yes	No	Yes	Yes	No	No	No	No	No	Yes	Yes	No
Hole punch	Yes	Yes	Yes	Yes	No	Yes	Yes	Yes	Yes	*4	Yes	Yes	Yes	Yes	Yes	Yes	Yes	Yes	Yes	Yes
Saddle stitch	Yes	Yes	Yes	No	No	No	Yes	No	Yes	*4	No	No	No	No	No	No	No	Yes	Yes	No
Rotate sort	Yes	Yes	Yes	Yes	No	No	Yes	Yes	Yes	*4	Yes	Yes	No	No	No	No	No	Yes	Yes	Yes
Image shift	Yes	Yes	Yes	Yes	Yes	No	Yes	Yes	Yes	*4	Yes	Yes	No	No	No	No	No	Yes	Yes	Yes
Edge erase	*3	*3	Yes	Yes	No	No	Yes	No	Yes	*4	Yes	Yes	Yes	Yes	Yes	Yes	Yes	Yes	Yes	Yes
Book center erase	Yes	Yes	Yes	Yes	Yes	No	Yes	Yes	Yes	Yes	Yes	Yes	No	No	No	No	No	Yes	Yes	Yes
Dual page	Yes	Yes	Yes	Yes	No	No	-	No	Yes	*4	Yes	Yes	No	No	No	No	No	Yes	Yes	No
Z/N1 / 4N1	*3	*3	Yes	Yes	No	No	Yes	Yes	Yes	Yes	Yes	Yes	No	No	No	No	No	No	No	No
Trim / Mask	Yes	Yes	Yes	Yes	No	No	Yes	Yes	Yes	No	Yes	Yes	No	No	No	No	No	No	No	No
Mirror	Yes	Yes	No	Yes	No	Yes	Yes	Yes	Yes	No	Yes	Yes	Yes	Yes	Yes	Yes	Yes	Yes	Yes	Yes
Nega/Pos	Yes	Yes	No	Yes	No	Yes	Yes	No	Yes	No	Yes	Yes	Yes	Yes	Yes	Yes	Yes	Yes	Yes	Yes
XY zoom	Yes	Yes	Yes	Yes	Yes	No	Yes	Yes	Yes	No	Yes	Yes	Yes	Yes	Yes	Yes	Yes	Yes	Yes	Yes
Front - Blank	*3	*3	Yes	Yes	*3	No	Yes	Yes	Yes	No	Yes	Yes	Yes	Yes	Yes	Yes	Yes	Yes	Yes	Yes
Front - Top copied	*3	*3	Yes	Yes	*3	No	Yes	Yes	Yes	No	Yes	Yes	Yes	Yes	Yes	Yes	Yes	Yes	Yes	Yes
Front - Both copied	*3	*3	Yes	Yes	*3	No	Yes	Yes	Yes	No	Yes	Yes	Yes	Yes	Yes	Yes	Yes	Yes	Yes	Yes
Back - Blank	*3	*3	Yes	Yes	*3	No	Yes	Yes	Yes	No	Yes	Yes	Yes	Yes	Yes	Yes	Yes	Yes	Yes	Yes
Back - Top copied	*3	*3	Yes	Yes	*3	No	Yes	Yes	Yes	No	Yes	Yes	Yes	Yes	Yes	Yes	Yes	Yes	Yes	Yes
Back - Both copied	*3	*3	Yes	Yes	*3	No	Yes	Yes	Yes	No	Yes	Yes	Yes	Yes	Yes	Yes	Yes	Yes	Yes	Yes
Back - Only back copied	*3	*3	Yes	Yes	*3	No	Yes	Yes	Yes	No	Yes	Yes	Yes	Yes	Yes	Yes	Yes	Yes	Yes	Yes
Sheet insertion	*3	*3	Yes	No	No	No	Yes	Yes	Yes	No	Yes	Yes	Yes	Yes	Yes	Yes	Yes	Yes	Yes	Yes
Time stamp	*3	*3	Yes	Yes	No	No	Yes	No	Yes	*4	Yes	Yes	Yes	Yes	Yes	Yes	Yes	Yes	Yes	Yes
Page number	*3	*3	Yes	Yes	No	No	Yes	No	Yes	*4	Yes	Yes	Yes	Yes	Yes	Yes	Yes	Yes	Yes	Yes
Job build	*4	*4	Yes	Yes	*4	No	Yes	*4	Yes	*4	Yes	Yes	Yes	Yes	Yes	Yes	Yes	Yes	Yes	Yes
Image direction	Yes	Yes	Yes	Yes	Yes	Yes	Yes	Yes	Yes	*4	Yes	Yes	Yes	Yes	Yes	Yes	Yes	Yes	Yes	Yes
Book <-> TABLET	Yes	Yes	Yes	Yes	Yes	Yes	Yes	Yes	Yes	*4	Yes	Yes	Yes	Yes	Yes	Yes	Yes	Yes	Yes	Yes
ADF->SADF	Yes	Yes	Yes	Yes	Yes	Yes	Yes	Yes	Yes	Yes	Yes	Yes	Yes	Yes	Yes	Yes	Yes	Yes	Yes	Yes
Full image	*3	*3	No	Yes	-	Yes	Yes	Yes	Yes	Yes	Yes	Yes	Yes	Yes	Yes	Yes	Yes	Yes	Yes	Yes
Image repeat	No	No	No	Yes	No	No	Yes	Yes	Yes	Yes	Yes	Yes	Yes	Yes	Yes	Yes	Yes	Yes	Yes	Yes
Omit blank page	Yes	Yes	Yes	Yes	Yes	Yes	Yes	Yes	Yes	Yes	Yes	Yes	Yes	Yes	Yes	Yes	Yes	Yes	Yes	Yes
Outside erase	Yes	Yes	Yes	Yes	Yes	Yes	Yes	Yes	Yes	Yes	Yes	Yes	Yes	Yes	Yes	Yes	Yes	Yes	Yes	Yes
Copy & File	Yes	Yes	Yes	Yes	Yes	Yes	Yes	Yes	Yes	Yes	Yes	Yes	Yes	Yes	Yes	Yes	Yes	Yes	Yes	Yes
Store to e-File	No	No	No	No	No	No	No	No	No	No	No	No	No	No	No	No	No	No	No	No

*1 Size selection is required.
 *2 Size selection is required for [DOUBLE STAPLE] and [REAR STAPLE].
 *3 The function set later will be valid.
 *4 The setting cannot be changed from 2nd job or later.
 *5 Bookbinding margin is not available.

Combination matrix 2/2

	2IN1 / 4IN1	Dual page center erase	Edge erase	Image shift	Finishing				2-sided				Photo zoom	Mixed original sizes	Bypass copy	
					Rotate sort/Saddle stitch	Hole punch	Magazine sort & Center fold/Saddle stitch	Magazine sort & Center fold	Magazine sort	Staple sort	Group	Sort				Non-sort / Non-staple
Bypass copy	*3	*1	*1	*1	*1	*1	*1	*1	*1	*1	*1	*1	*1	*1	*1	
Mixed original sizes	No	No	No	No	No	No	No	No	No	No	No	No	No	No	No	
Photo zoom	*3	*3	Yes	Yes	Yes	Yes	Yes	Yes	Yes	Yes	Yes	Yes	Yes	Yes	Yes	
2-sided	1 - 1 Simplex	*3	Yes	Yes	Yes	Yes	Yes	Yes	Yes	Yes	Yes	Yes	Yes	Yes	Yes	
	1 - 2 Duplex	*3	No	Yes	Yes	Yes	Yes	Yes	Yes	Yes	Yes	Yes	Yes	Yes	Yes	
2-sided	2 - 1 Split	*3	No	Yes	Yes	Yes	Yes	Yes	Yes	Yes	Yes	Yes	Yes	Yes	Yes	
	2 - 2 Duplex	*3	No	Yes	Yes	Yes	Yes	Yes	Yes	Yes	Yes	Yes	Yes	Yes	Yes	
Book - 2	No	No	Yes	Yes	Yes	Yes	Yes	Yes	Yes	Yes	Yes	Yes	Yes	Yes	Yes	
Non-sort / Non-staple	Yes	Yes	Yes	Yes	Yes	Yes	Yes	Yes	Yes	Yes	Yes	Yes	Yes	Yes	Yes	
Sort	Yes	Yes	Yes	Yes	Yes	Yes	Yes	Yes	Yes	Yes	Yes	Yes	Yes	Yes	Yes	
Group	Yes	Yes	Yes	Yes	Yes	Yes	Yes	Yes	Yes	Yes	Yes	Yes	Yes	Yes	Yes	
Staple sort	Yes	Yes	Yes	Yes	Yes	Yes	Yes	Yes	Yes	Yes	Yes	Yes	Yes	Yes	Yes	
Magazine sort	No	No	Yes	No	Yes	Yes	Yes	Yes	Yes	Yes	Yes	Yes	Yes	Yes	Yes	
Center fold	No	No	Yes	No	Yes	Yes	Yes	Yes	Yes	Yes	Yes	Yes	Yes	Yes	Yes	
Magazine sort & Saddle stitch	No	No	Yes	No	Yes	Yes	Yes	Yes	Yes	Yes	Yes	Yes	Yes	Yes	Yes	
Magazine sort & Center fold	No	No	Yes	No	Yes	Yes	Yes	Yes	Yes	Yes	Yes	Yes	Yes	Yes	Yes	
Hide punch	Yes	Yes	No	Yes	No	No	No	No	No	No	No	No	No	No	No	
Saddle stitch	No	No	No	Yes	No	*3	*3	*3	*3	*3	*3	*3	*3	*3	*3	
Rotate sort	Yes	No	Yes	Yes	No	*3	*3	*3	*3	*3	*3	*3	*3	*3	*3	
Image shift	Yes	No	Yes	Yes	Yes	Yes	Yes	Yes	Yes	Yes	Yes	Yes	Yes	Yes	Yes	
Edge erase	Yes	Yes	Yes	Yes	Yes	Yes	Yes	Yes	Yes	Yes	Yes	Yes	Yes	Yes	Yes	
Book center erase	Yes	Yes	Yes	Yes	Yes	Yes	Yes	Yes	Yes	Yes	Yes	Yes	Yes	Yes	Yes	
Dual page	No	No	No	No	No	No	No	No	No	No	No	No	No	No	No	
2IN1 / 4IN1	No	No	No	No	No	No	No	No	No	No	No	No	No	No	No	
Trim / Mask																
Mirror																
Nega/Pos																
XY zoom																
Cover sheet	Front - Blank															
	Front - Top copied															
	Front - Both copied															
	Back - Blank															
	Back - Top copied															
Sheet insertion	Back - Both copied															
	Back - Only back copied															
Time stamp																
Page number																
Job build																
Image direction																
Book <-> TABLET																
ADF -> SADF																
Full image																
Image repeat																
Omit blank page																
Outside erase																
Copy & File																
Store to e-File																

*1 Size selection is required.
 *2 Size selection is required for [DOUBLE STAPLE] and [REAR STAPLE].
 *3 The function set later will be valid.
 *4 The setting cannot be changed from 2nd job or later.
 *5 Bookbinding margin is not available.

Image Adjustment Function Combination Matrix

■ Combination matrix 1/2

	ADF scan noise reduction	Saturation	Hue	Red & Black range adjustment	Twin color selectable adjustment	Sharpness	Background adjustment	Marker	One touch adjustment			RGB adjustment	Color balance
									Clear	Vivid	Cool		
Density Manual/Auto	Yes	Yes	Yes	Yes	Yes	Yes	*1	Yes	Yes	Yes	Yes	Yes	Yes
Full color	Yes	Yes	Yes	No	No	Yes	Yes	Yes	Yes	Yes	Yes	Yes	Yes
Auto color	Yes	Yes	Yes	No	No	Yes	Yes	No	No	No	No	Yes	Yes
Black	Yes	No	No	No	No	Yes	Yes	No	No	No	No	No	Yes
Color mode	Yes	No	No	No	Yes	Yes	Yes	No	No	No	No	No	No
Twin color copy — Twin color selectable	Yes	No	No	Yes	Yes	Yes	Yes	No	No	No	No	No	No
Twin color copy — Red & Black	Yes	No	No	No	Yes	Yes	Yes	No	No	No	No	No	No
Mono color	Yes	No	No	No	No	Yes	Yes	No	No	No	No	No	No
Text/Photo	Yes	Yes	Yes	Yes	Yes	Yes	Yes	Yes	Yes	Yes	Yes	Yes	Yes
Text	Yes	Yes	Yes	Yes	Yes	Yes	Yes	Yes	Yes	Yes	Yes	Yes	Yes
Photo	Yes	Yes	Yes	No	No	Yes	Yes	Yes	Yes	Yes	Yes	Yes	Yes
Original Mode	Yes	Yes	Yes	Yes	Yes	Yes	Yes	Yes	Yes	Yes	Yes	Yes	Yes
Printed image	Yes	Yes	Yes	Yes	Yes	Yes	Yes	Yes	Yes	Yes	Yes	Yes	Yes
Map	Yes	Yes	Yes	No	No	Yes	Yes	Yes	Yes	Yes	Yes	Yes	Yes
Image smoothing	Yes	No	No	No	No	Yes	Yes	No	No	No	No	No	No
Color balance	Yes	Yes	Yes	No	No	Yes	Yes	No	No	No	No	No	No
RGB adjustment	Yes	Yes	Yes	No	No	Yes	Yes	No	No	No	No	No	No
Warm	Yes	No	No	No	No	No	No	No	No	No	No	No	No
Cool	Yes	No	No	No	No	No	No	No	No	No	No	No	No
Vivid	Yes	No	No	No	No	No	No	No	No	No	No	No	No
Clear	Yes	No	No	No	No	No	No	No	No	No	No	No	No
Marker	Yes	No	No	No	No	No	No	No	No	No	No	No	No
Background adjustment	Yes	No	No	No	No	No	No	No	No	No	No	No	No
Sharpness	Yes	Yes	Yes	Yes	Yes	Yes	Yes	Yes	Yes	Yes	Yes	Yes	Yes
Twin color selectable adjustment	Yes	Yes	Yes	Yes	Yes	Yes	Yes	Yes	Yes	Yes	Yes	Yes	Yes
Red & Black range adjustment	Yes	No	No	No	No	No	No	No	No	No	No	No	No
Hue	Yes	No	No	No	No	No	No	No	No	No	No	No	No
Saturation	Yes	Yes	Yes	Yes	Yes	Yes	Yes	Yes	Yes	Yes	Yes	Yes	Yes
ADF scan noise reduction	Yes	Yes	Yes	Yes	Yes	Yes	Yes	Yes	Yes	Yes	Yes	Yes	Yes

*1 Only available with manual adjustment

Combination matrix 2/2

	Original Mode					Color mode					Density Manual /Auto	
	Image smoothing	Map	Printed image	Photo	Text	Text/Photo	Mono color	Twin color copy & Black	Twin color copy Twin color selectable	Black		Auto color
Density Manual /Auto	Yes	Yes	Yes	Yes	Yes	Yes	Yes	Yes	Yes	Yes	Yes	Yes
Full color	No	Yes	Yes	Yes	Yes	Yes	No	No	No	No	No	No
Auto color	No	No	Yes	No	Yes	Yes	No	No	No	No	No	No
Black	Yes	No	No	Yes	Yes	Yes	No	No	No	No	No	No
Twin color copy — Twin color selectable	No	No	Yes	No	Yes	Yes	No	No	No	No	No	No
Twin color copy — Red & Black	No	No	Yes	No	Yes	Yes	No	No	No	No	No	No
Mono color	No	Yes	Yes	Yes	Yes	Yes	Yes	Yes	Yes	Yes	Yes	Yes
Text/Photo	No	No	No	No	No	No	No	No	No	No	No	No
Text	No	No	No	No	No	No	No	No	No	No	No	No
Photo	No	No	No	No	No	No	No	No	No	No	No	No
Printed image	No	No	No	No	No	No	No	No	No	No	No	No
Map	No	No	No	No	No	No	No	No	No	No	No	No
Image smoothing	No	No	No	No	No	No	No	No	No	No	No	No
Color balance												
RGB adjustment												
Warm												
Cool												
Vivid												
Clear												
Marker												
Background adjustment												
Sharpness												
Twin color selectable adjustment												
Red & Black range adjustment												
Hue												
Saturation												
ADF scan noise reduction												

*1 Only available with manual adjustment

INDEX

Numerics

2IN1 / 4IN1	97
[2-SIDED]	8

A

A/B format	11
ADF	120
ADF -> SADF	120
ADF Scan Noise Reduction	143
Alert message indication area	8
AMS (Automatic Magnification Selection)	57
[APS]	8, 50
APS (Automatic Paper Selection)	50
AUTO COLOR	54
Auto job start	33
Automatic function clear	37
Automatic Magnification Selection (AMS)	57
Automatic Paper Selection (APS)	50

B

BACKGROUND ADJUSTMENT	133
BASIC menu	8
[BASIC] tab	8
BLACK	54
BOOK - TABLET	119
BOOK CENTER ERASE	93
Bypass copying	
bypass copying	37
non-standard size paper	44
standard size paper	38
[BYPASS FEED]	10
Bypass tray	12, 37, 38, 44

C

Center fold	66, 72
Clearing the set functions	49
COLOR BALANCE	129
Color mode	
AUTO COLOR	54
BLACK	54
color mode	48, 54
FULL COLOR	54
Color mode buttons	9
Confirmation screen	48
Continuous feed mode	28
COPY & FILE	82
Copy quantity	48

Copying

auto job start	33
basic procedure	30
before making copies	24
book-type originals	26, 80
bypass copying	37
continuous copying speed	174
copy & file	82
copy quantity	48
duplex copying	77
interrupting	34
making copies	30
mixed-size originals	52
non-standard size paper	44
number of copies	30
photo originals	63
proof copy	35
reproduction ratio	48, 57
restarting	32
stopping	32
Copying function combination matrix	177
Copying functions	
before using copying functions	48
clearing the set functions	49
confirming the set functions	48
COVER SHEET	107

D

Default settings	48
Density adjustment	48, 56
Density adjustment buttons	9
Department management function	8
Drawer buttons	10
Drawers	
acceptable copy paper	11
buttons	10
confirming current status	170
placing paper	13
DUAL PAGE	95
Duplex copying	
1-sided original -> 1-sided copy	77
1-sided original -> 2-sided copy	77
2-sided original -> 1-sided copy	77
2-sided original -> 2-sided copy	77
book-type original -> 2-sided copy	77
simple/duplex setting	77

E

EDGE ERASE	92
EDIT menu	88
[EDIT] tab	8, 88
EDITING	102
masking	102
mirror image	105
negative/positive reversal	105
trimming	102

Editing functions	87	Image adjustment functions	
2IN1 / 4IN1	97	ADF Scan Noise Reduction	143
ADF -> SADF	120	BACKGROUND ADJUSTMENT	133
BOOK - TABLET	119	COLOR BALANCE	129
BOOK CENTER ERASE	93	HUE	141
COVER SHEET	107	Image adjustment functions	127
DUAL PAGE	95	MONO COLOR	140
EDGE ERASE	92	ONE-TOUCH ADJUSTMENT	132
EDITING	102	RGB ADJUSTMENT	131
FULL IMAGE	121	SATURATION	142
IMAGE DIRECTION	118	SHARPNESS	134
IMAGE REPEAT	122	TWIN COLOR COPY	135
IMAGE SHIFT	89	IMAGE DIRECTION	118
JOB BUILD	115	IMAGE menu	128
MAGAZINE SORT	100	IMAGE REPEAT	122
OMIT BLANK PAGE	124	IMAGE SHIFT	89
OUTSIDE ERASE	125	IMAGE SMOOTHING	55
PAGE NUMBER	113	[IMAGE] tab	8, 128
SHEET INSERTION	109	[INTERRUPT] button	34
TIME STAMP	112	Interrupting copying	34
XY ZOOM	106		
End guide	14	J	
Equipment status indication area	8, 10	JOB BUILD	115
[EXIT TRAY]	10	Job history	169
External Large Capacity Feeder	11, 22	[JOB STATUS]	9
		Job status	164
F		Job status menu	164
Feeding mode	28	Jobs	
Finisher		confirming	164
Finisher	66	deleting	165
name of each part	67	moving	166
Saddle Stitch Finisher	66	pausing / resuming	165
[FINISHING]	8	recovery information	168
Finishing mode		skipped	168
center fold	66, 72		
finishing mode	48	K	
group	66, 68	K format	11
hole punch	66, 75		
magazine sort	66, 72	L	
magazine sort & center fold	66	Log	169
magazine sort & saddle stitch	66, 72	LT format	11
manual staple	66, 76		
non-sort non-staple	66	M	
rotate sort	66, 69	MAGAZINE SORT	100
saddle stitch	66, 72	Magazine sort	66, 72
selecting	66	Magazine sort & center fold	66
sort	66, 68	Magazine sort & saddle stitch	66, 72
staple sort	66, 70	Manual staple	66, 76
FTP	84	MAP	55
FTPS	84	Message indication area	8
FULL COLOR	54	MONO COLOR	140
FULL IMAGE	121		
[FUNCTION CLEAR] button	37, 48, 49	N	
		NetWare IP	85
G		NetWare IPX	85
Group	66, 68	Non-sort Non-staple	66
		Number of copies	9, 30
H		Number of remaining copy sets	9
Help button	9		
Hole punch	66, 75	O	
Hole Punch Unit	66	OHP film	12, 37, 41
HUE	141	OMIT BLANK PAGE	124
		ONE-TOUCH ADJUSTMENT	132
I		Original glass	25
Image adjustment function combination matrix	179	[ORIGINAL MODE]	8, 55

Original mode		
IMAGE SMOOTHING	55	
MAP	55	
original mode	48, 55	
PHOTO	55	
PRINTED IMAGE	55	
TEXT	55	
TEXT/PHOTO	55	
Original stopper	28	
Originals		
acceptable originals	25	
mixed-size originals	52	
placing	25	
using the RADF	27	
OUTSIDE ERASE	125	
P		
PAGE NUMBER	113	
Paper		
acceptable copy paper	11	
amount of paper remaining	10	
out of paper	31	
paper type setting	17, 39, 43	
placing	11, 13, 20, 22	
precautions for storing copy paper	12	
registering paper size	16	
unacceptable copy paper	12	
Paper holder	37	
Paper selection	48, 50	
Paper size indicator	15	
Paper type on the bypass tray	10	
Paper type setting	17, 39, 43	
PHOTO	55	
Photo zoom	63	
Plain paper	11	
PRINTED IMAGE	55	
Private group		
changing private group data	157	
creating	152	
deleting	160	
private group	149	
registering templates	154	
[PROOF COPY]	9	
Proof copy	35	
Public template group	149	
R		
RADF (Reversing Automatic Document Feeder)		
precautions	27	
unacceptable originals	27	
using the RADF	27	
Receiving tray indication	10	
Receiving tray selection	36	
Recommended paper	11	
Recycled paper	11	
Registering paper size	16	
Reproduction ratio	48, 57	
Reversing Automatic Document Feeder (RADF)		
precautions	27	
unacceptable originals	27	
using the RADF	27	
RGB ADJUSTMENT	131	
Rotate sort	66, 69	
S		
Saddle stitch	66, 72	
SADF	120	
SATURATION	142	
[SETTINGS]	9	
Share folder	84	
SHARPNESS	134	
SHEET INSERTION	109	
Side guide lock	13	
Side guides of the bypass tray	38, 44	
Side guides of the drawer	13	
Side guides of the RADF		
(Reversing Automatic Document Feeder)	28, 29	
Simplex/duplex setting	48	
Single feed mode	29	
SMB	84	
Sort	66, 68	
Staple sort	66, 70	
Stapling control section	76	
[START] button	31, 33	
Sticker labels	12, 37	
[STOP] button	32	
[STORAGE]	9	
Storage of color copies	24	
T		
Tandem Large Capacity Feeder	11, 20	
[TEMPLATE]	9, 146	
Template menu	146	
Templates		
changing data	157, 158	
deleting	160, 161	
recalling	155	
registering	149, 154	
templates	146	
useful templates	147	
TEXT	55	
TEXT/PHOTO	55	
Thick paper	12	
TIME STAMP	112	
Toner remaining amount	171	
TopAccess	157	
Touch panel	8	
TWIN COLOR COPY	135	
U		
Useful templates	147	
[USER FUNCTIONS] button	16	
User management function	8	
W		
Waterproof paper	12	
X		
XY ZOOM	106	
Y		
YMCK adjustment	129	
Z		
[ZOOM]	8, 57	

MULTIFUNCTIONAL DIGITAL COLOR SYSTEMS

Copying Guide

e-STUDIO5560c/6560c/6570c

TOSHIBA TEC CORPORATION

1-11-1, OSAKI, SHINAGAWA-KU, TOKYO, 141-8562, JAPAN



R13102003301-TTEC
Ver01 F 2015-01